



Max Perlès
advanced industrial coatings



technical manual
waste water & desalination
BIOPERL systems

WASTE WATER & DESALINATION and *max perlès* **BIOPERL®** coatings for treatment and storage works

Why waste water and desalination works should be protected :

Optimized Asset Management :

To prevent or to stop the degradation of infrastructure, hence significantly increasing its life expectancy and operating period, therefore generating a *positive return on the investment in the coating*.

Functionally :

- **on a concrete substrate** : to obtain a *waterproof* or *watertight* surface that can furthermore *resist certain degrees of cracking in a concrete substrate* as well as *counter-pressure* through the concrete . The coating is either single-coat , “ watertight “ , resisting future cracking in the substrate of up to 2/10ths of a mm , or is a waterproof composite of epoxy resin reinforced with glass tissue or mat , that will resist future cracking in the substrate of up to 20/10ths of a mm , depending on the weight of the glass reinforcement used .
- **on a steel substrate** : to apply an anti-corrosion and protective film to the steel surface.

Technically :

- To *protect municipal and industrial waste water treatment plants and installations from premature degradation* due to the various aggressive gases waste waters emits , and notably hydrogen sulphide (H₂S) .
- To *protect desalination plants from premature degradation* due to the detrimental impact on concrete and steel of prolonged contact with salt water .
- To greatly *facilitate and accelerate cleaning and maintenance operations* due to the smooth finish of the coating .
- To conform with toxicological and sanitary regulations applicable in most countries

Advantages of max perlès coatings :

Health and Safety :

They are *solvent-free* and made of *non-toxic and non-polluting substances* . This *protects the environment* and allows them to be applied under *health and safety conditions* vital for both the personnel involved and the quality of the implementation. In particular , they *contain no carcinogenic or mutagenic substances or substances that are toxic to reproduction (CMRs)*.

Experience and references :

They are the result of unmatched expertise and experience : our solvent-free epoxy *coatings* for the protection of waste water treatment plants have been implemented by qualified applicators on worksites worldwide *since 1965*.

Quality Assurance :

Our Research & Development and Technical Assistance Departments work in collaboration to develop our products' reliability, as well as to fine-tune new products, for a quality that we strive to always improve – *a must for ISO 9001-2015 certification* – to better meet the users' expectations and those of an *environment* more and more strictly governed by *regulations*.

Technical Assistance :

Our Technical Assistance department offers upon request training or advice to application companies by assisting them before and/or during their work. It also operates post-application visits upon request by the applicator or the end customer to detect possible defects.

Independent Testing :

Our coatings are tested by certified laboratories . Test results are available on request .

Guaranteed reliability :

Max Perlès coating systems are guaranteed for the duration indicated on the specification supplied for each project . This guarantee is based on a specific *Insurance Policy* issued by a world-class Insurance Company . Our application partners , once trained by us , should supply a similar guarantee on their workmanship . The end customer can then request from the manufacturer/applicator partnership a *Joint Guarantee* indicating that any failure of the coating during the warranty period resulting from bad product quality or its incorrect application will be corrected free of charge for the client.

UPWARDS OF 10 MILLION SQM OF CAPACITIES HAVE BEEN PROTECTED WITH
OUR PRODUCTS OVER THE LAST 60 YEARS.

Foreword : Applicable Norms , Rules and Regulations

Summary

- 1 Uses of BIOPERL® systems
- 2 Description of BIOPERL® functionalities
- 3 Nature and quality of acceptable substrates
- 4 Specifications
- 5 Performance testing and retouching
- 6 Technical assistance
- 7 Commissioning
- 8 Servicing / Maintenance / Repairs
- 9 Qualification of application companies
- 10 Warranty – modalities and operation

Appendix 1

List of performance criteria supplied as per Annex 2 of the Fascicule 74
CE marking and Performance Declaration
Origin of the products

Appendix 2

Product data sheets

Appendix 3

Technical advices n°1, 2, 3, 4, 5, 7, 14 and 21

Appendix 4

Reference list



Waterproof , Watertight and Protective coatings

Foreword : Applicable Norms , Rules and Regulations

Concrete substrates

Fascicule 74

NF EN 1992-1 Chapter 7.3.1

NF EN 1992-3 Chapter 7.3.1

Steel substrates

AFNOR ICS 82 Paints and Varnishes

NF T 36-001: Technical Dictionnary of Paints and Paintwork

ISO 12944 : applicable to new work only

NF EN ISO 3450

ISO -8501-1-2& 3

ISO 8502 -1-2-3-4 & 5



Waterproof , Watertight and Protective coatings

January 2024
*waste water
manual*

Bibliography

Fascicule 74 version 4.01 – May 2021

ITBTP Publications : « Recommandations professionnelles Mai 1990 » (how to calculate and implement waterproofing to reservoirs , basins and tanks , whether overground or underground , open or closed)

OHGPI : Circulars G32 & G37

Laboratoire de Recherche des Monuments Historiques : visible alterations in concrete , diagnosis

SETRA /LCPC : Choice and implementation of products for the repair and protection of concrete

French Civil Works Association : November 2003 - Rehabilitation of degraded concrete

GESIP –UIC-UFIP : Catalog and classification of Civil Works disorders (SEVESO III retentions)

It is the application company's responsibility to respect all the rules and regulations applicable in the country where the coating work is carried out .

1. Uses of BIOPERL® systems

BIOPERL® systems are epoxy coatings based on thermo-hardening polymers , containing no solvents , presented in pre-dosed kits of two separate components (a base and a hardener) , to be applied *in situ* , in one or more coats , inside the different parts of Municipal and Industrial Waste Water Treatment Plants and Desalination Plants , on B & C class concrete or steel substrates . The standard topcoat finish of BIOPERL® T will be replaced by a novolac-epoxy GELCOAT SV101 topcoat in certain chemical environments .

Main Uses :

BIOPERL® systems supply an interior , watertight protective coating to the different components of Municipal and Industrial Waste Water Treatment Plants and Desalination Plants - reservoirs , storage and clarification basins , retention pits , gutters , vats , vessels , digesters , thickeners , desanding pools , settling and flocculation tanks etc.... – whether they contain municipal waste water , industrial waste water , salt water , brackish water or other aggressive waters , industrial liquids up to 95 °C , aggressive gases such as H₂S and methane , base or acid reagents etc....

They therefore apply to both concrete and steel works , whether new or being rehabilitated or repaired :

- For new concrete coating work : single-layer watertight epoxy systems , capable of resisting future cracking in the concrete substrate of up to 2/10 ths of a mm – see system sheets 301 & 311.
- For both new and remedial coating work on concrete : multi-layer waterproof epoxy systems , reinforced with a multi-axial glass tissue that provides the capability of absorbing without damage existing and future cracking in the concrete substrate of 10/10 ths, 15/10 ths and 20/10 ths of a mm , depending on the weight of the glass tissue reinforcement chosen - see system sheets 101, 102, 103, 107, 108,109, 111, 112, 113, 117, 118,119.
- For both new and remedial protective coating work on steel : single-layer anti-corrosion epoxy systems as per the French OHGPI G32 and G37 regulation – see system sheets 401 and 402 .

Limits of use :

- These types of coatings are not applicable to “D” type structures (prefabricated elements) , as mentioned in 3.3.4. of the Professional Recommendations of the ITBTP Publications (DTU 56/ Fascicule 74 and NF EN 1992-3) .
- BIOPERL® systems are not applicable to situations where the operating temperature of the content is above 95 °C .
- The degree of aggressiveness of certain *industrial effluents* may be higher than the chemical tolerance of our BIOPERL® systems . *Please consult us systematically to obtain a tailor-made specification to suit the case you are working on .*



2. Description of BIOPERL[®] functionalities

The distinction between waterproofing and watertightening refers to current european normalisation - NF EN 1504-2 – as well as to Fascicule 74 .

Adherent waterproofing, applicable to class C new or existing concrete buildings :

Consists of a coating capable of absorbing without damage mechanical stresses generated in particular by quantified substrate crackings and some counterpressures, while ensuring perfect inertia with respect to the chemical environment (cf. 4.1.2.1. of the ITBTP Publication) with which it is in contact.

This system consists of a jointless , reinforced coating based on BIOPERL[®] R solvent-free epoxy resin reinforced with glass tissue and with either a BIOPERL[®] T or a GELCOAT SV101 topcoat , depending on the liquid or gas involved .

Adherent watertightness, applicable to class B new or existing concrete buildings :

Consists of a coating that brings watertightness to a concrete capacity as long as this remains stable as per NF EN 1992-3 : no cracking above 2/10 ths of a mm and no un-drained counter-pressure . Ensures perfect inertia with respect to the chemical environment (cf. 4.1.2.1. of the ITBTP Publications) with which it is in contact.

This system consists of a continuous BIOPERL[®] T single-layer coating, non-reinforced and adherent to the substrate except on existing cracks which must be bridged over with a reinforcing band of glass tissue.

Anticorrosion protection, applicable to new or existing steel buildings :

Consists of a coating that will remain inert in contact with its chemical environment (cf. 4.1.2.1 of the ITBTP Publication) , while providing anti-corrosion protection to the steel on which it is applied.

This system consists of a a continuous BIOPERL[®] T single-layer coating , non-reinforced and adherent , of varying thickness depending on the aggressiveness of the content .

3. Nature and quality of acceptable substrates.

Whether new or old , substrates should be the object of a written assessment carried out jointly by the civil works contractor and the application contractor before proceeding with the coating works , describing the condition of the surface , quantifying and qualifying any existing disorders and determining who is responsible to carry out the necessary corrections .

- ***New concrete must be left to dry for at least 28 days before coating and old concrete must be in good condition*** , designed, calculated and constructed in conformity with the prescriptions of the regulatory texts mentioned in the reference documents.

This applies in particular to the state of the surface : are deemed acceptable surface conditions obtained and/or restored using solutions proposed in our system sheets – see Chapter 4 below - and in our ***Technical Advice Nr. 1 “Specification for preparation of concrete”*** - see Appendix 3.

The state of the surface must be of a good quality as indicated in the NFP 18-201 Standard – Technical Specification – ref. DTU 23.1 and in chapters 7-3-1 of Norm NF EN 1992-1 & 1992-3 (EUROCODE N°2).

Any products used for the repair of the concrete must be validated prior to application by the application contractor to make sure they are compatible with our coatings and that no risk exists of them creating a difference in potential between old and new concrete parts that could cause degradation in the concrete and corrosion of the steel reinforcement .

- ***New or old steel*** structures must be within the limits defined in ISO 8501-1, and referred to in the OHGPI circular G32 and G37.



Waterproof , Watertight and Protective coatings

4 –Reinforced waterproof coating systems conforming to Fascicule 74

Sheet 111 **450 g/sqm-reinforced coating** Bioperl® R with Bioperl® T topcoat – 2.0 mm
SOCOTEC conformity certificate n° : 23108808000034

Sheet 112 **800 g/sqm-reinforced coating** Bioperl® R with Bioperl® T topcoat – 2,5 mm

Sheet 113 **1200 g/sqm-reinforced coating** Bioperl® R with Bioperl® T topcoat – 3.0 mm

Note :

Systems 111, 112 and 113 consist of the same Primer, Epoxy resin and topcoat. Their chemical resistances are therefore identical. As systems 112 and 113 integrate glass fiber reinforcing tissues that are heavier than the one in system 111, it is their mechanical performances that are higher.

Consequently, systems 112 et 113 also conform to Fascicule 74 and SOCOTEC's conformity certificate no. also applies to these two systems.

Fiche système n°111

BIOPERL® / P45

Version novembre 2023

Revêtement d'Étanchéité Adhérent (REA) de type Composite Adhérent (CAD) à base de résines époxydiques armées.
Attestation de conformité au Fascicule 74 V04.01 (mai 2021) : SOCOTEC n° 231068080000034 (validité 30/11/2029)

Domaine d'emploi :

Revêtement d'étanchéité adhérent pour ouvrages de stockage et de process d'eau brute, pluviale, usée ou gaz à température < 60°C (digesteurs, clarificateurs, décanteurs, dessableurs, épaisseurs, floculateurs)

constitué de : époxy renforcé de 450 g/m² de fibres de verre

Application : radier, voiles et sous-face de toit

Types d'ouvrages : aériens, semi-enterrés,
enterrés avec présence de nappe phréatique
jusqu'à 10m de hauteur d'eau

support : béton de type C
neuf ou en très bon état de surface

© Tous droits réservés – 2023 Conformément à l'article L122-4 : Toute représentation ou reproduction intégrale ou partielle faite sans notre consentement écrit et explicite est illicite. Il en est de même pour la traduction, l'adaptation ou la transformation, l'arrangement ou la reproduction par un art ou un procédé quelconque.

Composition du système :

Bioperl®/P45 est un système de revêtement à base de résines époxydiques bi-composants.

Les consommations ci-dessous concernent les applications en horizontal, vertical et sous-face de toit.

	Produit	Consommation
Primaire		
Primaire	SCREENPERL	250 g/m ²
Enduit		
Couche de ragréage éventuelle	Enduit AR100	En fonction de l'état de surface
Revêtement ⁽¹⁾		
Imprégnation	BIOPERL R	750 g/m ²
Renfort	Tissu de verre multi-axial P45	450 g/m ²
Saturation ⁽²⁾	BIOPERL R	550 g/m ²
Finition		
Fermeture	BIOPERL T	800 g/m ²

(1) : La stratification (imprégnation, pose du tissu, saturation) se fait en continu dans un délai maximum de 2 heures à 20°C.

(2) : La couche de saturation doit être saupoudrée de Silice SB 0 par pulvérisation mécanique.

Epaisseur totale minimale (hors primaire et enduit) : 2mm

Les consommations ci-dessus sont théoriques et ne prennent pas en compte un certain nombre d'éléments pouvant les augmenter, comme le traitement des points singuliers, les pertes, etc...

Il conviendra de retenir un **coefficient de majoration** pour l'estimation de la consommation pratique : **15% minimum**, selon méthode, moyens adoptés et selon les conditions d'application.

MAX PERLES

4 rue du Professeur Dubos – BP 80439

60119 Hénonville Cedex (France)

Tél : 33 (0) 3 44 49 86 22 – www.maxperles.com

Caractéristiques des produits :

Produits	Conditionnements	Durée Pratique d'Utilisation (D.P.U.) à +20°C	Délai de recouvrement à +20°C	Température de stockage
Screenperl (primaire)	8 kg Base : 4.8 kg Durcisseur : 3.2 kg	35 minutes	Mini 4 heures Maxi 15 jours	Mini +5°C Maxi +35°C
BIOPERL® R (imprégnation, saturation)	12 kg Base : 9 kg Durcisseur : 3 kg	1 h 10	Mini 24 heures Maxi 7 jours	Mini +5°C Maxi +35°C
BIOPERL® T (finition)	12 kg Base : 9 kg Durcisseur : 3 kg	40 minutes	sans objet	Mini +5°C Maxi +35°C

Se reporter aux fiches techniques des produits concernés.

Identification des produits :

Les composants sont identifiés par :

- N° de lot : (xxxxxxx) suite de 8 chiffres
- Date de péremption : jour/mois/année
- Date de fabrication : jour/mois/année

MAX PERLES

4 rue du Professeur Dubos – BP 80439

60119 Hénonville Cedex (France)

Tél : 33 (0) 3 44 49 86 22 – www.maxperles.com

Spécification de préparation des bétons:

Pour ouvrage de type C selon Fascicule 74

La bonne tenue des revêtements d'étanchéité dépend de la qualité du support et de sa préparation qui doit permettre d'obtenir une cohésion superficielle d'au moins (mesure par l'essai de traction directe, après décapage de la couche de laitance superficielle) :

- Ouvrages neufs : 1.5 MPa
- Ouvrages en rénovation avec hauteur d'eau inférieure à 12m : 1 MPa
- Ouvrages en rénovation avec hauteur d'eau supérieure ou égale à 12m : 1.5 MPa

Après imprégnation du béton au primaire :

Pontage si nécessaire des fissures existantes avec un adhésif plastifié (toilé ou de type PVC) de 10cm de large (*sauf en cas de contre-pression d'eau non drainée*)

Conditions de mise en œuvre :

- Doivent être conformes aux indications de nos fiches et conseils techniques.
- **Température ambiante Ta** : $+5^{\circ}\text{C} \leq \text{Ta} \leq 35^{\circ}\text{C}$
- **Température d'application Tp** : $+10^{\circ}\text{C} \leq \text{Tp} \leq 30^{\circ}\text{C}$
- **Humidité relative HR** : $\text{HR} \leq 85\%$
- **Température du support** : $+5^{\circ}\text{C}$ minimum - $+30^{\circ}\text{C}$ maximum et $+3^{\circ}\text{C}$ minimum au-dessus du point de rosée

Matériel de mise en œuvre :

L'entreprise applicatrice doit disposer du matériel d'application et de contrôle nécessaire au bon déroulement du chantier (thermo-hydromètre, malaxeur, rouleaux à poils mi-longs, pompe airless, taloche, rouleaux débulleurs, jauge humide, Dynatest, balai diélectrique...)

Précaution d'utilisation des produits :

Pour une utilisation en toute sécurité des produits, les utilisateurs doivent consulter la fiche de données de sécurité (FDS) la plus récente contenant les données toxicologiques, environnementales et autres données relatives à la sécurité. Nos FDS sont disponibles sur le site www.quickfds.com .

MAX PERLES

4 rue du Professeur Dubos – BP 80439

60119 Hénonville Cedex (France)

Tél : 33 (0) 3 44 49 86 22 – www.maxperles.com

Document de mise en œuvre :

- Préparation des supports :
[Conseil Technique n°1](#) « Spécification de préparation des bétons »
- Mise en œuvre du revêtement :
[Conseil Technique n°14](#) « Stratification verre/résine », [Conseil Technique n°7](#) « Engravure d'un stratifié »
- Contrôle d'exécution :
[Conseil Technique n°3](#) « Contrôles d'efficacité » et [Conseil Technique n°4](#) « Contrôle di-électrique »
- Retouches :
[Conseil Technique n°5](#) « Retouches »

Référentiel :

- Fascicule 74 version 4.01 – mai 2021

Délai de remise en service :

7 jours minimum à 20°C conformément aux exigences du fascicule 74.

MAX PERLES

4 rue du Professeur Dubos – BP 80439

60119 Hénonville Cedex (France)

Tél : 33 (0) 3 44 49 86 22 – www.maxperles.com

Tableau des éléments de preuves de la fiche système n°111 : Bioperl®/P45

N° Preuve	Caractéristiques d'aptitude à l'emploi	Méthode d'essai	Spécifications	Performances
EXIGENCES GENERALES DU SYSTEME				
1	Perméabilité à l'eau = étanchéité pression directe d'eau	NF P 18-855	Etanche 1 MPa	Etanche 1 MPa
4	Etanchéité autour des pénétrations et des points singuliers	Justification par les descriptions et dessins du dossier technique du fabricant du procédé et du fascicule 74	Voir Fascicule 74 - Annexe 4	cahier traitement des points singuliers
7	Traitement des fissures existantes	Justification par les descriptions et dessins du dossier technique du fabricant du procédé et du fascicule 74	Voir Fascicule 74 - Annexe 4	cahier traitement des points singuliers
8	Perméabilité à la vapeur d'eau	NF EN ISO 7783	Préciser la valeur en s_d VDF	$S_d > 24m$
10	Perméabilité à l'H ₂ S	ASTM D3985 Estimation de l'H ₂ S à partir de l'oxygène	VDF	Perméabilité $> 2.5 \text{ cm}^3 / \text{m}^2 \cdot 24h \cdot \text{bar}$
13	Perméabilité au CO ₂	NF EN 1062-6	Préciser la valeur en s_d VDF	$S_d > 4368 \text{ m}$
15	Evaluation de la capacité à suivre les déformations admissibles du support béton par un essai de traction sur film libre	Méthode M1	Déformation au premier défaut VDF Déformation a rupture défaut VDF	Conforme selon interprétation du GCEE
16	Détermination de l'étanchéité sous déformation admissible par un essai de pression sur support métallique	Méthode M2	Etanche à la déformation requise	Conforme selon interprétation du GCEE
22	Caractéristiques mécaniques en traction à 23°C	NF EN ISO 527-1 à 4	VDF	$>40 \text{ MPa}$
24	Traitement des fissures existantes	Justification par les descriptions et dessins du dossier technique du fabricant	Voir Fascicule 74 - Annexe 4	cahier traitement des points singuliers

MAX PERLES

4 rue du Professeur Dubos – BP 80439

60119 Hénonville Cedex (France)

Tél : 33 (0) 3 44 49 86 22 – www.maxperles.com

N° Preuve	Caractéristiques d'aptitude à l'emploi	Méthode d'essai	Spécifications	Performances
25	Adhérence au support béton sec A la température ambiante et aux conditions limites (température et délai de recouvrement, minimum et maximum) revendiquées par le fabricant	NF EN 1542 Epreuve béton MC(0,40) suivant la norme NF EN 1766	Contrainte de traction à la rupture \geq 1,5 MPa (avec indication du mode de rupture)	A 30°C : > 2MPa (100% cohésif support) A 10°C : > 2MPa (100% cohésif support)
26	Adhérence au support béton humide A la température ambiante et aux conditions limites (température et délai de recouvrement, minimum et maximum) revendiquées par le fabricant	NF EN 13578	Contrainte de traction à la rupture \geq 1,5 MPa (avec indication du mode de rupture)	A 10°C et 30°C > 2 MPa (100% cohésif béton)
27	Adhérence état initial, 23°C	Vieillessement par immersion suivant NF EN ISO 2812-1 Adhérence suivant NF EN 1542 Epreuve béton MC(0,40) suivant la norme NF EN 1766	Contrainte de traction à la rupture \geq 1,5 MPa (avec indication du mode de rupture)	Contrainte minimum > 5 MPa (100% cohésif support)
28	Adhérence après immersion 60 jrs dans l'eau à 23°C			Adhérence > 5 MPa (100% cohésif support)
35	Adhérence sur accessoires (métal, plastique, ...)	CCT du fabricant du procédé		Adhérence sur métal > 2MPa Attente RAPPORT
36	Etanchéité à l'eau des fixations par chevilles chimiques	Voir schémas du fascicule 74 Essai d'étanchéité suivant NF P18 855 dans le cas de percement de l'étanchéité	Conservation de l'étanchéité après mise en œuvre de la cheville. Compatibilité entre la résine de scellement et le revêtement.	Etanche 1 MPa
50	Reprofilage du parement	Le fabricant propose une ou des solution(s) dans son système.	Voir Fascicule 74 - article 7	cahier traitement des points singuliers

MAX PERLES

4 rue du Professeur Dubos – BP 80439

60119 Hénonville Cedex (France)

Tél : 33 (0) 3 44 49 86 22 – www.maxperles.com

N° Preuve	Caractéristiques d'aptitude à l'emploi	Méthode d'essai	Spécifications	Performances
51	Conditions d'ambiance lors de la mise en œuvre et du séchage	Respect du fascicule 74 et du dossier technique du fabricant pour les températures d'application, l'humidité relative et les délais de recouvrement	Contrôlé in situ par l'applicateur avec rapport journalier voir Fascicule 74 - article 10	Fiche Technique produits
57	Essai de résistance au cloquage sous pression capillaire ou osmotique	Essai de cloquage (essai CSTB)	Ni cloque, ni perte d'adhérence	Pas de cloque > 2 MPa
58	Transport et stockage des produits du procédé	Prescription	Suivre les recommandations du fabricant	Fiche Technique produits
59	Mise en œuvre	Hygiène et sécurité	Voir FDS et fiche technique	Fiche Technique produits FDS : disponibles sur quickfds Voir paragraphe mise en service
63	Délai de remise en service	Justification par le fabricant suivant le procédé	7 jours minimum EDCH et liquides alimentaires	Voir paragraphe mise en service
EXIGENCES RELATIVE A LA DURABILITE				
66	Résistance chimique aux liquides agressifs et produits de nettoyage (homologués pour EDCH) et désinfection	NF EN 13529	Le fabricant précise pour chaque produit les tenues aux agents chimiques en précisant la durée, la température, la concentration. Pour une rétention permanente, l'essai devra être conduit pendant au minimum 90 jours.	Etude au cas par cas en fonction des liquides
71	Absorption après immersion 60 jrs dans l'eau à 23°C	NF ISO 14223 adaptée	≤ 2,5%	Absorption ≤ 2.0%
82	Vieillessement eau chaude à 60°C pendant 180 jours	NF EN 1542 Adhérence sur support béton à 23°C	Pas de bulle, fissure, ni délamination après vieillissement Adhérence supérieure à 1MPa	Absence de défaut et Adhérence ≥ 2 MPa
85	Etanchéité à une contre-pression d'eau (nappe phréatique)	Norme NF P 18-855	exprimée en hauteur d'eau telle que définie au DTU 14.1	Valeur hauteur d'eau maximale : 10m
94	Entretien et nettoyage	Prescription	Suivre la notice d'entretien du fabricant et du guide ASTEE	Conseil technique n°25

MAX PERLES

4 rue du Professeur Dubos – BP 80439

60119 Hénonville Cedex (France)

Tél : 33 (0) 3 44 49 86 22 – www.maxperles.com

N°	Caractéristiques	Méthode d'essai	Spécifications	Performances
Preuve	d'aptitude à l'emploi			
107	Réparation suivant mode opératoire du fabricant	Essai d'adhérence suivant NF EN 1542 sur le système réparé	Contrainte de traction à la rupture $\geq 1,0$ MPa (avec rupture cohésive béton)	Adhérence ≥ 3 MPa (100% cohésif béton)

EXIGENCES RELATIVE A L'IDENTIFICATION DES PRODUITS (Contrôles)

110	Masse volumique	NF EN 2811-1 à 4	VDF sur composants	<table border="1"> <thead> <tr> <th></th> <th>Base</th> <th>Durc.</th> </tr> </thead> <tbody> <tr> <td>Screenperl</td> <td>1.14</td> <td>1.00</td> </tr> <tr> <td>Enduit AR100</td> <td>1.97</td> <td>1.32</td> </tr> <tr> <td>Bioperl R</td> <td>1.52</td> <td>0.99</td> </tr> <tr> <td>Bioperl T</td> <td>1.47</td> <td>1.01</td> </tr> </tbody> </table>		Base	Durc.	Screenperl	1.14	1.00	Enduit AR100	1.97	1.32	Bioperl R	1.52	0.99	Bioperl T	1.47	1.01																														
	Base	Durc.																																															
Screenperl	1.14	1.00																																															
Enduit AR100	1.97	1.32																																															
Bioperl R	1.52	0.99																																															
Bioperl T	1.47	1.01																																															
111	Viscosité aux températures normale et limites indiquées par le fabricant	NF EN ISO 3219	VDF sur composants	<table border="1"> <thead> <tr> <th colspan="3">Viscosité à 10°C (en poises)</th> </tr> <tr> <th></th> <th>Base</th> <th>Durc.</th> </tr> </thead> <tbody> <tr> <td>Screenperl</td> <td>163</td> <td>86</td> </tr> <tr> <td>Bioperl R</td> <td>274</td> <td>111</td> </tr> <tr> <td>Bioperl T</td> <td>372</td> <td>89</td> </tr> <tr> <th colspan="3">Viscosité à 20°C (en poises)</th> </tr> <tr> <th></th> <th>Base</th> <th>Durc.</th> </tr> <tr> <td>Screenperl</td> <td>23</td> <td>24</td> </tr> <tr> <td>Bioperl R</td> <td>61</td> <td>24</td> </tr> <tr> <td>Bioperl T</td> <td>101</td> <td>20</td> </tr> <tr> <th colspan="3">Viscosité à 30°C (en poises)</th> </tr> <tr> <th></th> <th>Base</th> <th>Durc.</th> </tr> <tr> <td>Screenperl</td> <td>7</td> <td>8</td> </tr> <tr> <td>Bioperl R</td> <td>24</td> <td>5</td> </tr> <tr> <td>Bioperl T</td> <td>48</td> <td>5</td> </tr> </tbody> </table>	Viscosité à 10°C (en poises)				Base	Durc.	Screenperl	163	86	Bioperl R	274	111	Bioperl T	372	89	Viscosité à 20°C (en poises)				Base	Durc.	Screenperl	23	24	Bioperl R	61	24	Bioperl T	101	20	Viscosité à 30°C (en poises)				Base	Durc.	Screenperl	7	8	Bioperl R	24	5	Bioperl T	48	5
Viscosité à 10°C (en poises)																																																	
	Base	Durc.																																															
Screenperl	163	86																																															
Bioperl R	274	111																																															
Bioperl T	372	89																																															
Viscosité à 20°C (en poises)																																																	
	Base	Durc.																																															
Screenperl	23	24																																															
Bioperl R	61	24																																															
Bioperl T	101	20																																															
Viscosité à 30°C (en poises)																																																	
	Base	Durc.																																															
Screenperl	7	8																																															
Bioperl R	24	5																																															
Bioperl T	48	5																																															
112	Durée Pratique d'Utilisation (DPU) aux températures normale et limites indiquées par le fabricant	NF EN ISO 9514	VDF sur composants	<table border="1"> <thead> <tr> <th></th> <th colspan="3">D.P.U.</th> </tr> <tr> <th></th> <th>10°C</th> <th>20°C</th> <th>30°C</th> </tr> </thead> <tbody> <tr> <td>Screenperl</td> <td>2h</td> <td>0h35</td> <td>0h10</td> </tr> <tr> <td>Enduit AR100</td> <td>4h00</td> <td>2h00</td> <td>1h00</td> </tr> <tr> <td>Bioperl R</td> <td>3h15</td> <td>1h10</td> <td>0h30</td> </tr> <tr> <td>Bioperl T</td> <td>2h15</td> <td>0h40</td> <td>0h10</td> </tr> </tbody> </table>		D.P.U.				10°C	20°C	30°C	Screenperl	2h	0h35	0h10	Enduit AR100	4h00	2h00	1h00	Bioperl R	3h15	1h10	0h30	Bioperl T	2h15	0h40	0h10																					
	D.P.U.																																																
	10°C	20°C	30°C																																														
Screenperl	2h	0h35	0h10																																														
Enduit AR100	4h00	2h00	1h00																																														
Bioperl R	3h15	1h10	0h30																																														
Bioperl T	2h15	0h40	0h10																																														
113	Dureté Shore D à 2 et 7 jours aux températures normale et limites indiquées par le fabricant	NF EN 868	VDF sur composants	<table border="1"> <thead> <tr> <th colspan="4">Durété Shore après 2 jours.</th> </tr> <tr> <th></th> <th>10°C</th> <th>20°C</th> <th>30°C</th> </tr> </thead> <tbody> <tr> <td>Bioperl T</td> <td>61</td> <td>77</td> <td>77</td> </tr> </tbody> </table>	Durété Shore après 2 jours.					10°C	20°C	30°C	Bioperl T	61	77	77																																	
Durété Shore après 2 jours.																																																	
	10°C	20°C	30°C																																														
Bioperl T	61	77	77																																														

MAX PERLES

4 rue du Professeur Dubos – BP 80439

60119 Hénonville Cedex (France)

Tél : 33 (0) 3 44 49 86 22 – www.maxperles.com



N° Preuve	Caractéristiques d'aptitude à l'emploi	Méthode d'essai	Spécifications	Performances
--------------	---	-----------------	----------------	--------------

				Durété Shore après 7 jours.			
				10°C	20°C	30°C	
				Bioperl T	73	79	80
114	Extrait sec	NF EN ISO 3251	VDF sur composants	Extrait sec.			
				Screenperl	98.7		
				Bioperl R	99.3		
				Bioperl T	98.6		
115	Teneur en cendres	NF EN ISO 3451-1	VDF sur composants		Base	Durc.	
				Screenperl	0	0	
				Enduit AR100	80	36	
				Bioperl R	45	0	
				Bioperl T	45	0	

MAX PERLES

4 rue du Professeur Dubos – BP 80439
60119 Hénonville Cedex (France)
Tél : 33 (0) 3 44 49 86 22 – www.maxperles.com

Waterproof fiberglass-reinforced epoxy protective coating

- made of:* solvent-free epoxy reinforced with 450 g/sqm of fiberglass
- for:* the waterproofing and protection of wastewater and desalination structures, such as digesters, thickeners, storage & clarifying basins, desanding pools, settling & flocculation tanks.
- in contact with:* domestic and industrial wastewaters, seawater and aggressive waters or gases (H₂S, methane) at t° < 60°C
- substrate:* new concrete or existing concrete in good condition

Preparation as per [Technical Advice nr 1](#)
“Specification for preparation of concrete”, and as a minimum:

- ◆ **Obtaining** a healthy and homogeneous substrate, free from laitance, loose particles and dust, over 100 microns surface roughness, using appropriate mechanical means
 - ◆ **Removal** of dust with industrial vacuum cleaner
 - ◆ **Impregnation** of concrete with solvent free conductive epoxy **Screenperl®**, using a roller, **250 g/sqm**, **Silica SB 0** to be sprinkled after 1h minimum and before 2h30 maximum, **400g/sqm**.
 - ◆ **Bridging** of existing cracks with a 10 cm wide plasticized adhesive tape
(except if there exists a risk of un-drained counter-pressure)
 - ◆ **Rendering** of surface defects with epoxy **Render AR100**
- Proper adherence of a coating depends on the quality of the substrate and on its surface preparation. **Surface cohesion must be 1,5 MPa minimum** in the case of new concrete and **1 MPa minimum** in the case of rehabilitation of existing concrete.

System Bioperl® / P45 – thickness 2 mm*:

- ◆ **Uninterrupted laminate** of fiberglass/epoxy as per [Technical Advice nr 14](#), comprising:
 - Bioperl® R** coat for **impregnation**, using a roller, **550 microns**, **750 g/sqm**
 - Glassfabric P45** to be unrolled, and debubbled using a special roller, **450 g/sqm**
 - Bioperl® R** coat for **saturation**, using a roller, **400 microns**, **550 g/sqm**
 - Silica SB0** to be sprinkled while progressing by mechanical projection, **400 g/sqm**
- ◆ **Checking** as per [Technical Advice nr 3](#) “Performance testing” and [nr 4](#) “Dielectric testing”
- ◆ **Repair** of defects as per [Technical Advice nr 5](#) “Retouching”
- ◆ **Topcoat** one coat of **Bioperl® T**, using airless spray or roller, **600 microns**, **800 g/sqm**

* When only partially coating a vertical surface (such as walls), we recommend that the top of the coating be stopped in an engraving (see TA nr. 7 and sketch nr. 8)

Application conditions:

A **loss factor** has to be added for practical consumption, **about 15%**, according to means and methods used.

Reference documents :

Civil Works Fascicule 74 and NF EN 1992-3 for C Class Structures.

Guarantee: 10 years

Including **resistance to existing and bridged substrate cracks of up to 20/10th mm**, **resistance to new cracks of up to 10/10th mm** and **resistance to counter-pressure through the substrate of up to 1 bar** (10 meters of water).

*This proposal is based on our n° FA0095300, products civil liability insurance policy “after delivery”, within its terms and limitations
To become effective, it must have been formalised in a duly signed guarantee commitment certificate.*

Waterproof fiberglass-reinforced epoxy protective coating

- made of:* solvent-free epoxy reinforced with 800 g/sqm of fiberglass
- for:* the waterproofing and protection of wastewater and desalination structures, such as digesters, thickeners, storage & clarifying basins, desanding pools, settling & flocculation tanks.
- in contact with:* domestic and industrial wastewaters, seawater and aggressive waters or gases (H₂S, methane) at t° < 60°C
- substrate:* new concrete or existing concrete in reasonably good condition

Preparation as per [Technical Advice nr 1](#)

“Specification for preparation of concrete”, and as a minimum:

- ♦ **Obtaining** a healthy and homogeneous substrate, free from laitance, loose particles and dust, over 100 microns surface roughness, using appropriate mechanical means
- ♦ **Removal** of dust with industrial vacuum cleaner
- ♦ **Impregnation** of concrete with solvent free conductive epoxy **Screenperl®**, using a roller, **250 g/sqm**, **Silica SB 0** to be sprinkled after 1h minimum and before 2h30 maximum, **400g/sqm**.
- ♦ **Bridging** of existing cracks with a 10 cm wide plasticized adhesive tape
(*except if there exists a risk of un-drained counter-pressure*)
- ♦ **Rendering** of surface defects with epoxy **Render AR100**

Proper adherence of a coating depends on the quality of the substrate and on its surface preparation. **Surface cohesion must be 1,5 MPa minimum** in the case of new concrete and **1 MPa minimum** in the case of rehabilitation of existing concrete.

System Bioperl® / P80 – thickness 2.5 mm*:

- ♦ **Uninterrupted laminate** of fiberglass/epoxy as per [Technical Advice nr 14](#), comprising:
Bioperl® R coat for **impregnation**, using a roller, **700 microns**, **950 g/sqm**
Glassfabric P80 to be unrolled, and debubbled using a special roller, **800 g/sqm**
Bioperl® R coat for **saturation**, using a roller, **500 microns**, **700 g/sqm**
Silica SB0 to be sprinkled while progressing by mechanical projection, **400 g/sqm**
- ♦ **Checking** as per [Technical Advice nr 3](#) “Performance testing” and [nr 4](#) “Dielectric testing”
- ♦ **Repair** of defects as per [Technical Advice nr 5](#) “Retouching”
- ♦ **Topcoat** one coat of **Bioperl® T**, using airless spray or roller, **600 microns**, **800 g/sqm**

* When only partially coating a vertical surface (such as walls), we recommend that the top of the coating be stopped in an engraving (see TA nr. 7 and sketch nr. 8)

Application conditions:

A **loss factor** has to be added for practical consumption, **about 15%**, according to means and methods used.

Reference documents :

Civil Works Fascicule 74 and NF EN 1992-3 for C Class Structures.

Guarantee:10 years

Including **resistance to existing and bridged substrate cracks of up to 20/10th mm**, **resistance to new cracks of up to 15/10th mm** and **resistance to counter-pressure through the substrate of up to 1 bar** (10 meters of water).

*This proposal is based on our n° FA0095300, products civil liability insurance policy “after delivery”, within its terms and limitations
To become effective, it must have been formalised in a duly signed guarantee commitment certificate.*

Waterproof fiberglass-reinforced epoxy protective coating

made of: solvent-free epoxy reinforced with 1200 g/sqm of fiberglass

for: the waterproofing and protection of wastewater and desalination structures, such as digesters, thickeners, storage & clarifying basins, desanding pools, settling & flocculation tanks.

in contact with: domestic and industrial wastewaters, seawater and aggressive waters or gases (H₂S, methane) at t° < 60°C

substrate: new or existing concrete

Preparation as per [Technical Advice nr 1](#)
“Specification for preparation of concrete”, and as a minimum:

- ◆ **Obtaining** a healthy and homogeneous substrate, free from laitance, loose particles and dust, over 100 microns surface roughness, using appropriate mechanical means
- ◆ **Removal Impregnation** of dust with industrial vacuum cleaner of concrete with solvent free conductive epoxy **Screenperl®**, using a roller, 250 g/sqm, Silica SB 0 to be sprinkled after 1h minimum and before 2h30 maximum, 400g/sqm.
- ◆ **Rendering** of surface defects with epoxy **Render AR100**

Proper adherence of a coating depends on the quality of the substrate and on its surface preparation. **Surface cohesion must be 1,5 MPa minimum** in the case of new concrete and **1 MPa minimum** in the case of rehabilitation of existing concrete.

System Bioperl® / P120 – thickness 3 mm*:

- ◆ **Uninterrupted laminate** of fiberglass/epoxy as per [Technical Advice nr 14](#), comprising:
 - Bioperl® R coat for **impregnation**, using a roller, 800 microns, 1100 g/sqm
 - Glassfabric P120 to be unrolled, and debubbled using a special roller, 1200 g/sqm
 - Bioperl® R coat for **saturation**, using a roller, 600 microns, 800 g/sqm
 - Silica SB0 to be sprinkled while progressing by mechanical projection, 400 g/sqm
- ◆ **Checking** as per [Technical Advice nr 3](#) “Performance testing” and [nr 4](#) “Dielectric testing”
- ◆ **Repair** of defects as per [Technical Advice nr 5](#) “Retouching”
- ◆ **Topcoat** one coat of **Bioperl® T**, using airless spray or roller, 600 microns, 800 g/sqm

* When only partially coating a vertical surface (such as walls), we recommend that the top of the coating be stopped in an engraving (see TA nr. 7 and sketch nr. 8)

Application conditions:

A **loss factor** has to be added for practical consumption, **about 15%**, according to means and methods used.

Reference documents :

Civil Works Fascicule 74 and NF EN 1992-3 for C Class Structures.

Guarantee: 10 years

Including the resistance to substrate cracks, existing or to come of up to 20/10th mm and resistance to counter-pressure through the substrate of up to 1 bar (10 meters of water).

This proposal is based on our n° FA0095300, products civil liability insurance policy “after delivery”, within its terms and limitations
To become effective, it must have been formalised in a duly signed guarantee commitment certificate.



Waterproof , Watertight and Protective coatings

5. Waterproof and watertight systems:

◆ Coatings by function and type of structure:

Waterproofing and protection in contact with liquids (agressive waters) or gases (H₂S, methane) at t° < 60°C

On new concrete or good quality existing concrete

Sheets	101	:	450g/sqm-reinforced coating BIOPERL® R with BIOPERL® T topcoat	– 2.0 mm
	102	:	800g/sqm-reinforced coating BIOPERL® R with BIOPERL® T topcoat	– 2,5 mm
	103	:	1200g/sqm-reinforced coating BIOPERL® R with BIOPERL® T topcoat	– 3.0 mm

Waterproofing and protection in contact with agressive liquids (to be defined) at t° ≤ 95°C

On new concrete or good quality existing concrete

Sheets	107 & 117:	450g/sqm-reinforced coating BIOPERL® R with GELCOAT SV101 topcoat	– 2.0 mm
	108 & 118 :	800g/sqm-reinforced coating BIOPERL® R with GELCOAT SV101 topcoat	– 2.5 mm
	109 & 119 :	1200g/sqm-reinforced coating BIOPERL® R with GELCOAT SV101 topcoat	– 3.0 mm

Watertightness and protection in contact with liquids (agressive waters) or gases (H₂S, methane) at t° < 60°C

On new concrete

Sheets	301 & 311:	Single coat BIOPERL® T	– 0.8 mm
--------	------------	-------------------------------	----------

Watertightness and anti-corrosion protection of immersed , emerged or marling areas in contact with liquids (agressive waters) or gases (H₂S , methane) at t° ≤ 50°C

On new or existing steel substrates

Sheets	401	:	Single coat BIOPERL® T	– 0.6 mm
	402	:	Single coat BIOPERL® T	– 1 mm

◆ Treatment of singular points:

Each structure and/or specification with one or more of these points should be treated according to the corresponding drawing(s).

Waterproof fiberglass-reinforced epoxy protective coating

- made of:* solvent-free epoxy reinforced with 450 g/sqm of fiberglass
- for:* the waterproofing and protection of wastewater and desalination structures, such as digesters, thickeners, storage & clarifying basins, desanding pools, settling & flocculation tanks.
- in contact with:* domestic and industrial wastewaters, seawater and aggressive waters or gases (H₂S, methane) at t° < 60°C
- substrate:* new concrete or existing concrete in good condition

Preparation as per [Technical Advice nr 1](#)
“Specification for preparation of concrete”, and as a minimum:

- ◆ **Obtaining** a healthy and homogeneous substrate, free from laitance, loose particles and dust, over 100 microns surface roughness, using appropriate mechanical means
 - ◆ **Removal** of dust with industrial vacuum cleaner
 - ◆ **Impregnation** of concrete with waterborne epoxy **Primer EDO**, using a roller, **250 g/sqm**
 - ◆ **Bridging** of existing cracks with a 10 cm wide plasticized adhesive tape
(*except if there exists a risk of un-drained counter-pressure*)
 - ◆ **Rendering** of surface defects with epoxy **Render AR100**
- Proper adherence of a coating depends on the quality of the substrate and on its surface preparation. **Surface cohesion must be 1,5 MPa minimum** in the case of new concrete and **1 MPa minimum** in the case of rehabilitation of existing concrete.

System Bioperl® / P45 – thickness 2 mm*:

- ◆ **Uninterrupted laminate** of fiberglass/epoxy as per [Technical Advice nr 14](#), comprising:
 - Bioperl® R** coat for **impregnation**, using a roller, **550 microns, 750 g/sqm**
 - Glassfabric P45** to be unrolled, and debubbled using a special roller, **450 g/sqm**
 - Bioperl® R** coat for **saturation**, using a roller, **400 microns, 550 g/sqm**
 - Silica SB0** to be sprinkled while progressing by mechanical projection, **400 g/sqm**
- ◆ **Checking** as per [Technical Advice nr 3](#) “Performance testing” and [nr 4](#) “Dielectric testing”
- ◆ **Repair** of defects as per [Technical Advice nr 5](#) “Retouching”
- ◆ **Topcoat** one coat of **Bioperl® T**, using airless spray or roller, **600 microns, 800 g/sqm**

* When only partially coating a vertical surface (such as walls), we recommend that the top of the coating be stopped in an engraving (see TA nr. 7 and sketch nr. 8)

Application conditions:

A **loss factor** has to be added for practical consumption, **about 15%**, according to means and methods used.

Reference documents :

Civil Works Fascicule 74 and NF EN 1992-3 for C Class Structures.

Guarantee: 10 years

Including **resistance to existing and bridged substrate cracks of up to 20/10th mm**, **resistance to new cracks of up to 10/10th mm** and **resistance to counter-pressure through the substrate of up to 1 bar** (10 meters of water).

*This proposal is based on our n° FA0095300, products civil liability insurance policy “after delivery”, within its terms and limitations
To become effective, it must have been formalised in a duly signed guarantee commitment certificate.*

Waterproof fiberglass-reinforced epoxy protective coating

- made of:* solvent-free epoxy reinforced with 800 g/sqm of fiberglass
- for:* the waterproofing and protection of wastewater and desalination structures, such as digesters, thickeners, storage & clarifying basins, desanding pools, settling & flocculation tanks.
- in contact with:* domestic and industrial wastewaters, seawater and aggressive waters or gases (H₂S, methane) at t° < 60°C
- substrate:* new concrete or existing concrete in reasonably good condition

Preparation as per [Technical Advice nr 1](#) “Specification for preparation of concrete”, and as a minimum:

- ♦ **Obtaining** a healthy and homogeneous substrate, free from laitance, loose particles and dust, over 100 microns surface roughness, using appropriate mechanical means
- ♦ **Removal** of dust with industrial vacuum cleaner
- ♦ **Impregnation** of concrete with waterborne epoxy **Primer EDO**, using a roller, **250 g/sqm**
- ♦ **Bridging** of existing cracks with a 10 cm wide plasticized adhesive tape
(except if there exists a risk of un-drained counter-pressure)
- ♦ **Rendering** of surface defects with epoxy **Render AR100**

Proper adherence of a coating depends on the quality of the substrate and on its surface preparation. **Surface cohesion must be 1,5 MPa minimum** in the case of new concrete and **1 MPa minimum** in the case of rehabilitation of existing concrete.

System Bioperl® / P80 – thickness 2.5 mm*:

- ♦ **Uninterrupted laminate** of fiberglass/epoxy as per [Technical Advice nr 14](#), comprising:
 - Bioperl® R** coat for **impregnation**, using a roller, **700 microns, 950 g/sqm**
 - Glassfabric P80** to be unrolled, and debubbled using a special roller, **800 g/sqm**
 - Bioperl® R** coat for **saturation**, using a roller, **500 microns, 700 g/sqm**
 - Silica SBO** to be sprinkled while progressing by mechanical projection, **400 g/sqm**
- ♦ **Checking** as per [Technical Advice nr 3](#) “Performance testing” and [nr 4](#) “Dielectric testing”
- ♦ **Repair** of defects as per [Technical Advice nr 5](#) “Retouching”
- ♦ **Topcoat** one coat of **Bioperl® T**, using airless spray or roller, **600 microns, 800 g/sqm**

* When only partially coating a vertical surface (such as walls), we recommend that the top of the coating be stopped in an engraving (see TA nr. 7 and sketch nr. 8)

Application conditions:

A **loss factor** has to be added for practical consumption, **about 15%**, according to means and methods used.

Reference documents :

Civil Works Fascicule 74 and NF EN 1992-3 for C Class Structures.

Guarantee: 10 years

Including **resistance to existing and bridged substrate cracks of up to 20/10th mm, resistance to new cracks of up to 15/10th mm and resistance to counter-pressure through the substrate of up to 1 bar (10 meters of water).**

*This proposal is based on our n° FA0095300, products civil liability insurance policy “after delivery”, within its terms and limitations
To become effective, it must have been formalised in a duly signed guarantee commitment certificate.*

Waterproof fiberglass-reinforced epoxy protective coating

made of: solvent-free epoxy reinforced with 1200 g/sqm of fiberglass

for: the waterproofing and protection of wastewater and desalination structures, such as digesters, thickeners, storage & clarifying basins, desanding pools, settling & flocculation tanks.

in contact with: domestic and industrial wastewaters, seawater and aggressive waters or gases (H₂S, methane) at t° < 60°C

substrate: new or existing concrete

Preparation as per [Technical Advice nr 1](#)
“Specification for preparation of concrete”, and as a minimum:

- ◆ **Obtaining** a healthy and homogeneous substrate, free from laitance, loose particles and dust, over 100 microns surface roughness, using appropriate mechanical means
- ◆ **Removal** of dust with industrial vacuum cleaner
- ◆ **Impregnation** of concrete with waterborne epoxy **Primer EDO**, using a roller, **250 g/sqm**
- ◆ **Rendering** of surface defects with epoxy **Render AR100**

Proper adherence of a coating depends on the quality of the substrate and on its surface preparation. **Surface cohesion must be 1,5 MPa minimum** in the case of new concrete and **1 MPa minimum** in the case of rehabilitation of existing concrete.

System Bioperl® / P120 – thickness 3 mm*:

- ◆ **Uninterrupted laminate** of fiberglass/epoxy as per [Technical Advice nr 14](#), comprising:
 - Bioperl® R** coat for **impregnation**, using a roller, **800 microns, 1100 g/sqm**
 - Glassfabric P120** to be unrolled, and debubbled using a special roller, **1200 g/sqm**
 - Bioperl® R** coat for **saturation**, using a roller, **600 microns, 800 g/sqm**
 - Silica SBO** to be sprinkled while progressing by mechanical projection, **400 g/sqm**
- ◆ **Checking** as per [Technical Advice nr 3](#) “Performance testing” and [nr 4](#) “Dielectric testing”
- ◆ **Repair** of defects as per [Technical Advice nr 5](#) “Retouching”
- ◆ **Topcoat** one coat of **Bioperl® T**, using airless spray or roller, **600 microns, 800 g/sqm**

* When only partially coating a vertical surface (such as walls), we recommend that the top of the coating be stopped in an engraving (see TA nr. 7 and sketch nr. 8)

Application conditions:

A **loss factor** has to be added for practical consumption, **about 15%**, according to means and methods used.

Reference documents :

Civil Works Fascicule 74 and NF EN 1992-3 for C Class Structures.

Guarantee: 10 years

Including the resistance to substrate cracks, existing or to come of up to 20/10th mm and resistance to counter-pressure through the substrate of up to 1 bar (10 meters of water).

This proposal is based on our n° FA0095300, products civil liability insurance policy “after delivery”, within its terms and limitations
To become effective, it must have been formalised in a duly signed guarantee commitment certificate.





Max
Perlès

sheet nr.107

Bioperl® / P45, topcoat Gelcoat SV101

Waterproof fiberglass-reinforced epoxy protective coating

made of: solvent-free epoxy reinforced with 450 g/sqm of fiberglass + specific novolac topcoat

for: the waterproofing and protection of wastewater and desalination structures, such as retention pits, gutters, vats, storage vessels

in contact with: aggressive liquids (to be defined), at $t^{\circ} \leq 95^{\circ}\text{C}$

substrate: new concrete or existing concrete in good condition

Preparation as per [Technical Advice nr 1](#) "Specification for preparation of concrete", and as a minimum:

- ♦ **Obtaining** a healthy and homogeneous substrate, free from laitance, loose particles and dust, over 100 microns surface roughness, using appropriate mechanical means
- ♦ **Removal** of dust with industrial vacuum cleaner
- ♦ **Impregnation** of concrete with waterborne epoxy **Primer EDO**, using a roller, **250 g/sqm**
- ♦ **Bridging** of existing cracks with a 10 cm wide plasticized adhesive tape
(*except if there exists a risk of un-drained counter-pressure*)
- ♦ **Rendering** of surface defects with epoxy **Render AR100**

Proper adherence of a coating depends on the quality of the substrate and on its surface preparation. **Surface cohesion must be 1,5 MPa minimum** in the case of new concrete and **1 MPa minimum** in the case of rehabilitation of existing concrete.

System Bioperl® / P45 with Gelcoat SV101 topcoat – thickness 2 mm*:

- ♦ **Uninterrupted laminate** of fiberglass/epoxy as per [Technical Advice nr 14](#), comprising:
 - Bioperl® R** coat for **impregnation**, using a roller, **550 microns, 750 g/sqm**
 - Glassfabric P45** to be unrolled, and debubbled using a special roller, **450 g/sqm**
 - Bioperl® R** coat for **saturation**, using a roller, **400 microns, 550 g/sqm**
 - Silica SBO** to be sprinkled while progressing by mechanical projection, **400 g/sqm**
- ♦ **Checking** as per [Technical Advice nr 3](#) "Performance testing" and [nr 4](#) "Dielectric testing"
- ♦ **Repair** of defects as per [Technical Advice nr 5](#) "Retouching"
- ♦ **Topcoat** novolac-epoxy **Gelcoat SV101** divided in 2 passes, using a medium bristle roller/flat brush, **600 microns, 800 g/sqm**

* When only partially coating a vertical surface (such as walls), we recommend that the top of the coating be stopped in an engraving (see TA nr. 7 and sketch nr. 8)

Application conditions:

A **loss factor** has to be added for practical consumption, **about 15%**, according to means and methods used.

Reference documents :

Civil Works Fascicule 74 and NF EN 1992-3 for C Class Structures.

Guarantee: up to 10 years, depending on liquid's aggressiveness

Including **resistance to existing and bridged substrate cracks of up to 20/10th mm**, **resistance to new cracks of up to 10/10th mm** and **resistance to counter-pressure through the substrate of up to 1 bar** (10 meters of water).

Reservations : surface colour may change, cleaning after contact with reagents within a period to be defined

*This proposal is based on our n° FA0095300, products civil liability insurance policy "after delivery", within its terms and limitations
To become effective, it must have been formalised in a duly signed guarantee commitment certificate.*



Max
Perlès

sheet nr.108

Bioperl® / P80, topcoat Gelcoat SV101

Waterproof fiberglass-reinforced epoxy protective coating

made of: solvent-free epoxy reinforced with 800 g/sqm of fiberglass + specific novolac topcoat

for: the waterproofing and protection of wastewater and desalination structures, such as retention pits, gutters, vats, storage vessels

in contact with: aggressive liquids (to be defined), at $t^{\circ} \leq 95^{\circ}\text{C}$

substrate: new concrete or existing concrete in reasonably good condition

Preparation as per [Technical Advice nr 1](#) "Specification for preparation of concrete", and as a minimum:

- ♦ **Obtaining** a healthy and homogeneous substrate, free from laitance, loose particles and dust, over 100 microns surface roughness, using appropriate mechanical means
- ♦ **Removal** of dust with industrial vacuum cleaner
- ♦ **Impregnation** of concrete with waterborne epoxy **Primer EDO**, using a roller, **250 g/sqm**
- ♦ **Bridging** of existing cracks with a 10 cm wide plasticized adhesive tape
(*except if there exists a risk of un-drained counter-pressure*)
- ♦ **Rendering** of surface defects with epoxy **Render AR100**

Proper adherence of a coating depends on the quality of the substrate and on its surface preparation. **Surface cohesion must be 1,5 MPa minimum** in the case of new concrete and **1 MPa minimum** in the case of rehabilitation of existing concrete.

System Bioperl® / P80 with Gelcoat SV101 topcoat – thickness 2.5 mm*:

- ♦ **Uninterrupted laminate** of fiberglass/epoxy as per [Technical Advice nr 14](#), comprising:
 - Bioperl® R** coat for **impregnation**, using a roller, **700 microns, 950 g/sqm**
 - Glassfabric P80** to be unrolled, and debubbled using a special roller, **800 g/sqm**
 - Bioperl® R** coat for **saturation**, using a roller, **500 microns, 700 g/sqm**
 - Silica SBO** to be sprinkled while progressing by mechanical projection, **400 g/sqm**
- ♦ **Checking** as per [Technical Advice nr 3](#) "Performance testing" and [nr 4](#) "Dielectric testing"
- ♦ **Repair** of defects as per [Technical Advice nr 5](#) "Retouching"
- ♦ **Topcoat** novolac-epoxy **Gelcoat SV101** divided in 2 passes, using a medium bristle roller/flat brush, **600 microns, 800 g/sqm**

* When only partially coating a vertical surface (such as walls), we recommend that the top of the coating be stopped in an engraving (see TA nr. 7 and sketch nr. 8)

Application conditions:

A **loss factor** has to be added for practical consumption, **about 15%**, according to means and methods used.

Reference documents :

Civil Works Fascicule 74 and NF EN 1992-3 for C Class Structures.

Guarantee: up to 10 years, depending on liquid's aggressiveness

Including **resistance to existing and bridged substrate cracks of up to 20/10th mm**, **resistance to new cracks of up to 15/10th mm** and **resistance to counter-pressure through the substrate of up to 1 bar** (10 meters of water).

Reservations : surface colour may change, cleaning after contact with reagents within a period to be defined

This proposal is based on our n° FA0095300, products civil liability insurance policy "after delivery", within its terms and limitations

To become effective, it must have been formalised in a duly signed guarantee commitment certificate.



Max
Perlès

sheet nr.109

Bioperl® / P120, topcoat Gelcoat SV101

Waterproof fiberglass-reinforced epoxy protective coating

made of: solvent-free epoxy reinforced with 1200 g/sqm of fiberglass + specific novolac topcoat

for: the waterproofing and protection of wastewater and desalination structures, such as retention pits, gutters, vats, storage vessels

in contact with: aggressive liquids (to be defined), at $t^{\circ} \leq 95^{\circ}\text{C}$

substrate: new or existing concrete

Preparation as per [Technical Advice nr 1](#)

“Specification for preparation of concrete”, and as a minimum:

- ♦ **Obtaining** a healthy and homogeneous substrate, free from laitance, loose particles and dust, over 100 microns surface roughness, using appropriate mechanical means
- ♦ **Removal** of dust with industrial vacuum cleaner
- ♦ **Impregnation** of concrete with waterborne epoxy **Primer EDO**, using a roller, **250 g/sqm**
- ♦ **Bridging** of existing cracks with a 10 cm wide plasticized adhesive tape
(*except if there exists a risk of un-drained counter-pressure*)
- ♦ **Rendering** of surface defects with epoxy **Render AR100**

Proper adherence of a coating depends on the quality of the substrate and on its surface preparation. **Surface cohesion must be 1,5 MPa minimum** in the case of new concrete and **1 MPa minimum** in the case of rehabilitation of existing concrete.

System Bioperl® / P120 with Gelcoat SV101 topcoat – thickness 3 mm*:

- ♦ **Uninterrupted laminate** of fiberglass/epoxy as per [Technical Advice nr 14](#), comprising:
 - Bioperl® R** coat for **impregnation**, using a roller, **800 microns, 1100 g/sqm**
 - Glassfabric P120** to be unrolled, and debubbled using a special roller, **1200 g/sqm**
 - Bioperl® R** coat for **saturation**, using a roller, **600 microns, 800 g/sqm**
 - Silica SBO** to be sprinkled while progressing by mechanical projection, **400 g/sqm**
- ♦ **Checking** as per [Technical Advice nr 3](#) “Performance testing” and [nr 4](#) “Dielectric testing”
- ♦ **Repair** of defects as per [Technical Advice nr 5](#) “Retouching”
- ♦ **Topcoat** novolac-epoxy **Gelcoat SV101** divided in 2 passes, using a medium bristle roller/flat brush, **600 microns, 800 g/sqm**

* When only partially coating a vertical surface (such as walls), we recommend that the top of the coating be stopped in an engraving (see TA nr. 7 and sketch nr. 8)

Application conditions:

A **loss factor** has to be added for practical consumption, **about 15%**, according to means and methods used.

Reference documents :

Civil Works Fascicule 74 and NF EN 1992-3 for C Class Structures.

Guarantee: up to 10 years, depending on liquid’s aggressiveness

Including the resistance to substrate cracks, existing or to come, up to 20/10th mm and resistance to counter-pressure through the substrate of up to 1 bar (10 meters of water).

Reservations : surface colour may change, cleaning after contact with reagents within a period to be defined

*This proposal is based on our n° FA0095300, products civil liability insurance policy “after delivery”, within its terms and limitations
To become effective, it must have been formalised in a duly signed guarantee commitment certificate.*



Max
Perlès

sheet nr.117

Bioperl® / P45, topcoat Gelcoat SV101

Waterproof fiberglass-reinforced epoxy protective coating

made of: solvent-free epoxy reinforced with 450 g/sqm of fiberglass + specific novolac topcoat

for: the waterproofing and protection of wastewater and desalination structures, such as retention pits, gutters, vats, storage vessels

in contact with: aggressive liquids (to be defined), at $t^{\circ} \leq 95^{\circ}\text{C}$

substrate: new concrete or existing concrete in good condition

Preparation as per [Technical Advice nr 1](#) "Specification for preparation of concrete", and as a minimum:

- ♦ **Obtaining** a healthy and homogeneous substrate, free from laitance, loose particles and dust, over 100 microns surface roughness, using appropriate mechanical means
- ♦ **Removal** of dust with industrial vacuum cleaner
- ♦ **Impregnation** of concrete with solvent free conductive epoxy **Screenperl®**, using a roller, **250 g/sqm**, **Silica SB 0** to be sprinkled after 1h minimum and before 2h30 maximum, **400g/sqm**.
- ♦ **Bridging** of existing cracks with a 10 cm wide plasticized adhesive tape
(*except if there exists a risk of un-drained counter-pressure*)
- ♦ **Rendering** of surface defects with epoxy **Render AR100**

Proper adherence of a coating depends on the quality of the substrate and on its surface preparation. **Surface cohesion must be 1,5 MPa minimum** in the case of new concrete and **1 MPa minimum** in the case of rehabilitation of existing concrete.

System Bioperl® / P45 with Gelcoat SV101 topcoat – thickness 2 mm*:

- ♦ **Uninterrupted laminate** of fiberglass/epoxy as per [Technical Advice nr 14](#), comprising:
Bioperl® R coat for **impregnation**, using a roller, **550 microns**, **750 g/sqm**
Glassfabric P45 to be unrolled, and debubbled using a special roller, **450 g/sqm**
Bioperl® R coat for **saturation**, using a roller, **400 microns**, **550 g/sqm**
Silica SB0 to be sprinkled while progressing by mechanical projection, **400 g/sqm**
- ♦ **Checking** as per [Technical Advice nr 3](#) "Performance testing" and [nr 4](#) "Dielectric testing"
- ♦ **Repair** of defects as per [Technical Advice nr 5](#) "Retouching"
- ♦ **Topcoat** novolac-epoxy **Gelcoat SV101** divided in 2 passes, using a medium bristle roller/flat brush, **600 microns**, **800 g/sqm**

* When only partially coating a vertical surface (such as walls), we recommend that the top of the coating be stopped in an engraving (see TA nr. 7 and sketch nr. 8)

Application conditions:

A **loss factor** has to be added for practical consumption, **about 15%**, according to means and methods used.

Reference documents :

Civil Works Fascicule 74 and NF EN 1992-3 for C Class Structures.

Guarantee: up to 10 years, depending on liquid's aggressiveness

Including **resistance to existing and bridged substrate cracks of up to 20/10th mm**, **resistance to new cracks of up to 10/10th mm** and **resistance to counter-pressure through the substrate of up to 1 bar** (10 meters of water).

Reservations : surface colour may change, cleaning after contact with reagents within a period to be defined

*This proposal is based on our n° FA0095300, products civil liability insurance policy "after delivery", within its terms and limitations
To become effective, it must have been formalised in a duly signed guarantee commitment certificate.*



Max
Perlès

sheet nr.118

Bioperl® / P80, topcoat Gelcoat SV101

Waterproof fiberglass-reinforced epoxy protective coating

made of: solvent-free epoxy reinforced with 800 g/sqm of fiberglass + specific novolac topcoat

for: the waterproofing and protection of wastewater and desalination structures, such as retention pits, gutters, vats, storage vessels

in contact with: aggressive liquids (to be defined), at $t^{\circ} \leq 95^{\circ}\text{C}$

substrate: new concrete or existing concrete in reasonably good condition

Preparation as per [Technical Advice nr 1](#) "Specification for preparation of concrete", and as a minimum:

- ♦ **Obtaining** a healthy and homogeneous substrate, free from laitance, loose particles and dust, over 100 microns surface roughness, using appropriate mechanical means
- ♦ **Removal** of dust with industrial vacuum cleaner
- ♦ **Impregnation** of concrete with solvent free conductive epoxy **Screenperl®**, using a roller, **250 g/sqm**, **Silica SB 0** to be sprinkled after 1h minimum and before 2h30 maximum, **400g/sqm**.
- ♦ **Bridging** of existing cracks with a 10 cm wide plasticized adhesive tape
(*except if there exists a risk of un-drained counter-pressure*)
- ♦ **Rendering** of surface defects with epoxy **Render AR100**

Proper adherence of a coating depends on the quality of the substrate and on its surface preparation. **Surface cohesion must be 1,5 MPa minimum** in the case of new concrete and **1 MPa minimum** in the case of rehabilitation of existing concrete.

System Bioperl® / P80 with Gelcoat SV101 topcoat – thickness 2.5 mm*:

- ♦ **Uninterrupted laminate** of fiberglass/epoxy as per [Technical Advice nr 14](#), comprising:
 - Bioperl® R** coat for **impregnation**, using a roller, **700 microns**, **950 g/sqm**
 - Glassfabric P80** to be unrolled, and debubbled using a special roller, **800 g/sqm**
 - Bioperl® R** coat for **saturation**, using a roller, **500 microns**, **700 g/sqm**
 - Silica SB0** to be sprinkled while progressing by mechanical projection, **400 g/sqm**
- ♦ **Checking** as per [Technical Advice nr 3](#) "Performance testing" and [nr 4](#) "Dielectric testing"
- ♦ **Repair** of defects as per [Technical Advice nr 5](#) "Retouching"
- ♦ **Topcoat** novolac-epoxy **Gelcoat SV101** divided in 2 passes, using a medium bristle roller/flat brush, **600 microns**, **800 g/sqm**

* When only partially coating a vertical surface (such as walls), we recommend that the top of the coating be stopped in an engraving (see TA nr. 7 and sketch nr. 8)

Application conditions:

A **loss factor** has to be added for practical consumption, **about 15%**, according to means and methods used.

Reference documents :

Civil Works Fascicule 74 and NF EN 1992-3 for C Class Structures.

Guarantee: up to 10 years, depending on liquid's aggressiveness

Including **resistance to existing and bridged substrate cracks of up to 20/10th mm**, **resistance to new cracks of up to 15/10th mm** and **resistance to counter-pressure through the substrate of up to 1 bar** (10 meters of water).

Reservations : surface colour may change, cleaning after contact with reagents within a period to be defined

This proposal is based on our n° FA0095300, products civil liability insurance policy "after delivery", within its terms and limitations

To become effective, it must have been formalised in a duly signed guarantee commitment certificate.



Max
Perlès

sheet nr.119

Bioperl® / P120, topcoat Gelcoat SV101

Waterproof fiberglass-reinforced epoxy protective coating

- made of:* solvent-free epoxy reinforced with 1200 g/sqm of fiberglass + specific novolac topcoat
- for:* the waterproofing and protection of wastewater and desalination structures, such as retention pits, gutters, vats, storage vessels
- in contact with:* aggressive liquids (to be defined), at $t^{\circ} \leq 95^{\circ}\text{C}$
- substrate:* new or existing concrete

Preparation as per [Technical Advice nr 1](#)
“Specification for preparation of concrete”, and as a minimum:

- ♦ **Obtaining** a healthy and homogeneous substrate, free from laitance, loose particles and dust, over 100 microns surface roughness, using appropriate mechanical means
- ♦ **Removal of dust** with industrial vacuum cleaner
- ♦ **Impregnation** of concrete with solvent free conductive epoxy **Screenperl®**, using a roller, **250 g/sqm**, **Silica SB 0** to be sprinkled after 1h minimum and before 2h30 maximum, **400g/sqm**.
- ♦ **Bridging** of existing cracks with a 10 cm wide plasticized adhesive tape
(*except if there exists a risk of un-drained counter-pressure*)
- ♦ **Rendering** of surface defects with epoxy **Render AR100**

Proper adherence of a coating depends on the quality of the substrate and on its surface preparation. **Surface cohesion must be 1,5 MPa minimum** in the case of new concrete and **1 MPa minimum** in the case of rehabilitation of existing concrete.

System Bioperl® / P120 with Gelcoat SV101 topcoat – thickness 3 mm*:

- ♦ **Uninterrupted laminate** of fiberglass/epoxy as per [Technical Advice nr 14](#), comprising:
Bioperl® R coat for **impregnation**, using a roller, **800 microns**, **1100 g/sqm**
Glassfabric P120 to be unrolled, and debubbled using a special roller, **1200 g/sqm**
Bioperl® R coat for **saturation**, using a roller, **600 microns**, **800 g/sqm**
Silica SB0 to be sprinkled while progressing by mechanical projection, **400 g/sqm**
- ♦ **Checking** as per [Technical Advice nr 3](#) “Performance testing” and [nr 4](#) “Dielectric testing”
- ♦ **Repair** of defects as per [Technical Advice nr 5](#) “Retouching”
- ♦ **Topcoat** novolac-epoxy **Gelcoat SV101** divided in 2 passes, using a medium bristle roller/flat brush, **600 microns**, **800 g/sqm**

* When only partially coating a vertical surface (such as walls), we recommend that the top of the coating be stopped in an engraving (see TA nr. 7 and sketch nr. 8)

Application conditions:

A loss factor has to be added for practical consumption, **about 15%**, according to means and methods used.

Reference documents :

Civil Works Fascicule 74 and NF EN 1992-3 for C Class Structures.

Guarantee: up to 10 years, depending on liquid’s aggressiveness

Including the resistance to substrate cracks, existing or to come, up to 20/10th mm and resistance to counter-pressure through the substrate of up to 1 bar (10 meters of water).

Reservations : surface colour may change, cleaning after contact with reagents within a period to be defined
This proposal is based on our n° FA0095300, products civil liability insurance policy “after delivery”, within its terms and limitations
To become effective, it must have been formalised in a duly signed guarantee commitment certificate.

Watertight coating

- made of:* single-layer solvent-free epoxy
- for:* the interior watertightness of wastewater and desalination structures, such as storage & clarifying basins, desanding pools, settling & flocculation tanks, gutters, glances, foul air ducts.
- in contact with:* domestic and industrial wastewaters, seawater and aggressive waters or gases (H₂S, methane) at t° < 60°C
- substrate:* new concrete

Preparation as per [Technical Advice nr.1](#)

“Specification for preparation of concrete”, and as a minimum:

- ◆ **Obtaining** a healthy and homogeneous ⁽²⁾ substrate, free from laitance, loose particles and dust, over 100 microns surface roughness, using appropriate mechanical means
- ◆ **Removal** of dust with industrial vacuum cleaner
- ◆ **Impregnation** of concrete with waterborne epoxy **Primer EDO**, using a roller, **250 g/sqm**
- ◆ **Bridging** of existing cracks with a 10 cm wide plasticized adhesive tape overlaid with a 20 cm wide strip of glassfabric tissue **R45, 450 g/sqm, impregnated and saturated with Bioperl® R at 250g/lm**, and sprinkled with **Silica SBO** while progressing
- ◆ **Complete rendering of the concrete surface** using our epoxy **Render AR100**, 600-800 g/sqm, depending on state of surface

Proper adherence of a coating depends on the quality of the substrate and on its surface preparation. **Surface cohesion must be 1,5 MPa minimum** in the case of new concrete and **1 MPa minimum** in the case of rehabilitation of existing concrete.

Bioperl® coating – thickness 0.8 mm:

- ◆ **Application** of **Bioperl® T**: in 1 layer using airless spray gun 45/1 minimum
Theoretical consumption: **1100 g/sqm for 800 microns**
or by roller in 2 coats of 400µ - 550g/sqm each, between 3 to 5 hours interval
or by roller in a 1st coat, 400µ - 550g/sqm, sprinkled mechanically with **silica SBO** by progressing and after drying, application of a 2nd coat, 400µ - 550g/sqm
- ◆ **Checking** as per [Technical Advice nr.3](#) “Performance testing” and [nr.4](#) “Dielectric testing”
- ◆ **Repair** of defects as per [Technical Advice nr.5](#) “Retouching”

Application conditions:

A **loss factor** has to be added for practical consumption, **about 15%**, according to means and methods used.

Reference documents :

Civil Works Fascicule 74 and NF EN 1992-3 for B Class Structures.

Guarantee: 10 years

Excluding any defects resulting from :

- an existing, un-bridged and/or un-reinforced crack, as per treatment specified above (“bridging”)
- a crack of more than 2/10th mm appearing after coating
- the counter-pressure exercised at the back of the coating by un-drained water.

This proposal is based on our n° FA0095300, products civil liability insurance policy “after delivery”, within its terms and limitations To become effective, it must have been formalised in a duly signed guarantee commitment certificate.



Watertight coating

- made of:* single-layer solvent-free epoxy
- for:* the interior watertightness of wastewater and desalination structures, such as storage & clarifying basins, desanding pools, settling & flocculation tanks, gutters, glances, foul air ducts.
- in contact with:* domestic and industrial wastewaters, seawater and aggressive waters or gases (H₂S, methane) at t° < 60°C
- substrate:* new concrete

Preparation as per [Technical Advice nr.1](#)

“Specification for preparation of concrete”, and as a minimum:

- ◆ **Obtaining** a healthy and homogeneous ⁽²⁾ substrate, free from laitance, loose particles and dust, over 100 microns surface roughness, using appropriate mechanical means
- ◆ **Removal** of dust with industrial vacuum cleaner
- ◆ **Impregnation** of concrete with solvent free conductive epoxy **Screenperl®**, using a roller, **250 g/sqm**, **Silica SB 0** to be sprinkled after 1h minimum and before 2h30 maximum, **400g/sqm**.
- ◆ **Bridging** of existing cracks with a 10 cm wide plasticized adhesive tape overlaid with a 20 cm wide strip of glassfabric tissue **R45**, **450 g/sqm**, **impregnated** and **saturated** with **Bioperl® R** at **250g/lm**, and sprinkled with **Silica SB0** while progressing
- ◆ **Complete rendering of the concrete surface** using our epoxy **Render AR100**, **600-800 g/sqm**, depending on state of surface

Proper adherence of a coating depends on the quality of the substrate and on its surface preparation. **Surface cohesion must be 1,5 MPa minimum** in the case of new concrete and **1 MPa minimum** in the case of rehabilitation of existing concrete.

Bioperl® coating – thickness 0.8 mm:

- ◆ **Application** of **Bioperl® T**: in 1 layer using airless spray gun 45/1 minimum
Theoretical consumption: **1100 g/sqm** for **800 microns**
or by roller in 2 coats of 400µ - 550g/sqm each, between 3 to 5 hours interval
or by roller in a 1st coat, 400µ - 550g/sqm, sprinkled mechanically with **silica SB0** by progressing and after drying, application of a 2nd coat, 400µ - 550g/sqm
- ◆ **Checking** as per [Technical Advice nr.3](#) “Performance testing” and [nr.4](#) “Dielectric testing”
- ◆ **Repair** of defects as per [Technical Advice nr.5](#) “Retouching”

Application conditions:

A **loss factor** has to be added for practical consumption, **about 15%**, according to means and methods used.

Reference documents :

Civil Works Fascicule 74 and NF EN 1992-3 for B Class Structures.

Guarantee: 10 years

Excluding any defects resulting from :

- an existing, un-bridged and/or un-reinforced crack, as per treatment specified above (“bridging”)
- a crack of more than 2/10th mm appearing after coating
- the counter-pressure exercised at the back of the coating by un-drained water.

This proposal is based on our n° FA0095300, products civil liability insurance policy “after delivery”, within its terms and limitations
To become effective, it must have been formalised in a duly signed guarantee commitment certificate.

sheet nr.401 Bioperl® 600μ, on Sa2.5 Steel

Anti-corrosion protective coating

- made of:* single-layer solvent-free epoxy
- for:* the interior protection of structures such as reservoirs, gasometers, industrial water tanks, screen cleaners, raising screws
- in contact with:* domestic and industrial wastewaters, seawater or brackish waters at $t^{\circ} \leq 50^{\circ}\text{C}$
- substrate:* new steel or steel in good surface state ⁽¹⁾

Preparation as per [Technical Advice nr.2](#)

“Specification for steel preparation”, and as a minimum:

- ◆ Grinding of barbs and welding projections until elimination, and of the weld beads and sharp angles for softening
- ◆ Blasting ⁽²⁾ by any appropriate means to obtain equivalent to Sa 2.5 standard, with a Medium G or a Rt 50-75 microns profile
- ◆ Removal of dust with industrial vacuum cleaner
- ◆ Application while progressing and before any flash-rusting of one stand-by coat of solvent free conductive epoxy **Screenperl®**, 40 μm dry film, 60 sqm. Silica SB 0 to be sprinkled after 1h minimum and before 2h30 maximum, 400g/sqm.

Bioperl® coating – thickness 0.6 mm:

- ◆ Application of **Bioperl® T**:
In 1 layer using airless spray 45/1 minimum,
Theoretical consumption: 800 g/sqm for 600 microns,
except extra thickness along the weldings
- ◆ Checking as per [Technical Advice nr.3](#) “Performance testing” and [nr.4](#) “Dielectric testing”
- ◆ Repair of defects as per [Technical Advice nr.5](#) “Retouching”

Application conditions:

A loss factor has to be added for practical consumption, **about 15%**, according to means and methods used.

Guarantee: 5 years.

In accordance with Circular G37 of the OHGPI.

This proposal is based on our n° FA0095300, products civil liability insurance policy “after delivery”, within its terms and limitations
To become effective, it must have been formalised in a duly signed guarantee commitment certificate.



- (1) This specification is for structures corroded to a maximum of state C as per ISO 8501-1 :
- On the assumption of an important corrosion where state D is reached without however being exceeded, a rendering of the corrosion cankers is necessary with **Render AR100**, solventfree epoxy charged with Silica.
 - If corrosion exceeds state D, the implementation of an **Bioperl® R system reinforced with glassfiber** is necessary before the application of the topcoat **Bioperl® T**.
- (2) In case of sweating of steel plates loaded with oily products, observe a 48 h delay after blasting before application.
If brown stains appear within the 48h, a new blasting of the affected areas must be done until they disappear.

Anti-corrosion protective coating

- made of:* single-layer solvent-free epoxy
- for:* the interior protection of structures such as reservoirs, gasometers, industrial water tanks, screen cleaners, raising screws
- in contact with:* domestic and industrial wastewaters, seawater or brackish waters at $t^{\circ} \leq 50^{\circ}\text{C}$
- substrate:* new steel or steel in good surface state ⁽¹⁾

Preparation as per [Technical Advice nr.2](#)

“Specification for steel preparation”, and as a minimum:

- ◆ Grinding of barbs and welding projections until elimination, and of the weld beads and sharp angles for softening
- ◆ Blasting ⁽²⁾ by any appropriate means to obtain equivalent to Sa 2.5 standard, with a Medium G or a Rt 50-75 microns profile
- ◆ Removal of dust with industrial vacuum cleaner
- ◆ Application while progressing and before any flash-rusting of one stand-by coat of solvent free conductive epoxy **Screenperl®**, 40 μm dry film, 60 sqm. Silica SB 0 to be sprinkled after 1h minimum and before 2h30 maximum, 400g/sqm.

Bioperl® coating – thickness 1 mm:

- ◆ Application of **Bioperl® T**:
In 1 layer using airless spray 45/1 minimum,
Theoretical consumption: **1350 g/sqm** for **1000 microns**,
except extra thickness along the weldings
- ◆ Checking as per [Technical Advice nr.3](#) “Performance testing” and [nr.4](#) “Dielectric testing”
- ◆ Repair of defects as per [Technical Advice nr.5](#) “Retouching”

Application conditions:

A loss factor has to be added for practical consumption, **about 15%**, according to means and methods used.

Guarantee: 5 years.

In accordance with Circular G37 of the OHGPI.

This proposal is based on our n° FA0095300, products civil liability insurance policy “after delivery”, within its terms and limitations
To become effective, it must have been formalised in a duly signed guarantee commitment certificate.



- (1) This specification is for structures corroded to a maximum of state C as per ISO 8501-1:
- On the assumption of an important corrosion where state D is reached without however being exceeded, a rendering of the corrosion cankers is necessary with **Render AR100**, solventfree epoxy charged with Silica.
 - If corrosion exceeds state D, the implementation of an **Bioperl® R system reinforced with glassfiber** is necessary before the application of the topcoat **Bioperl® T**.
- (2) In case of sweating of steel plates loaded with oily products, observe a 48 h delay after blasting before application.
If brown stains appear within the 48h, a new blasting of the affected areas must be done until they disappear.



**Max
Perlès**
advanced industrial coatings

Coating of concrete structures

August 2023

Dealing with singular points: Sketch Book

Layered presentation of a laminate coating

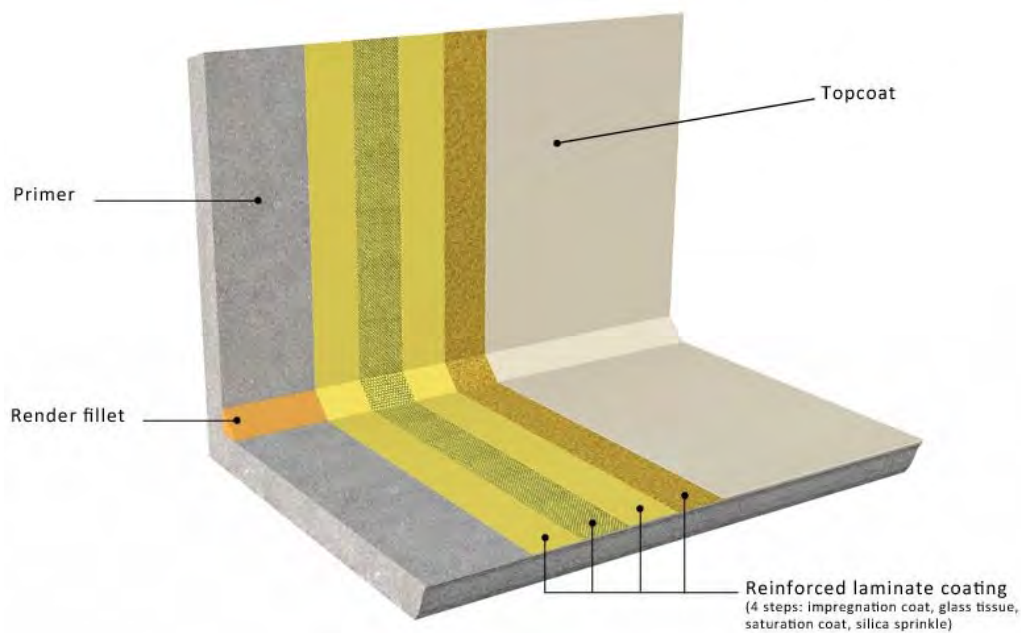

Sketch no.1: Treating a non active and non penetrating crack when applying a laminate coating

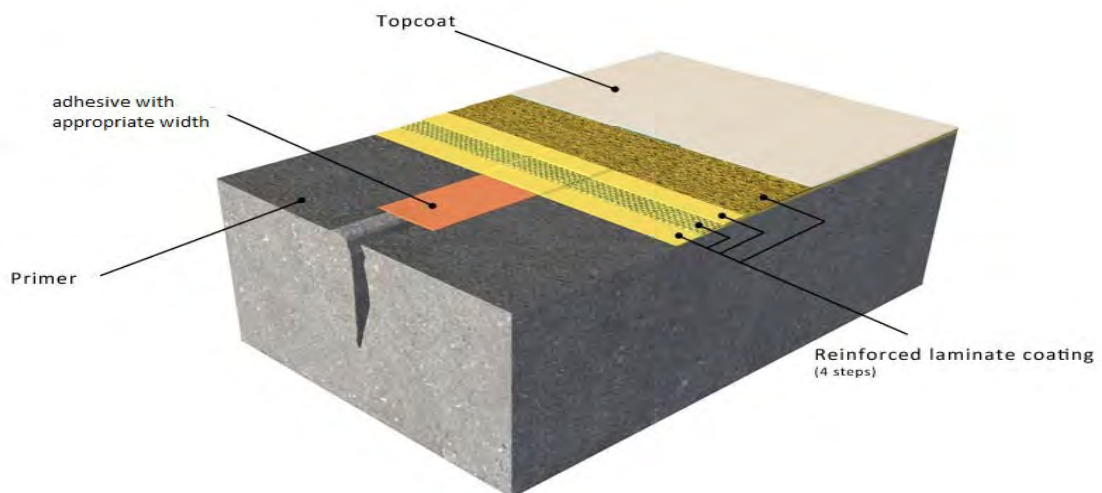

Sketch no.2: Treating a crack when applying a single-layer coating

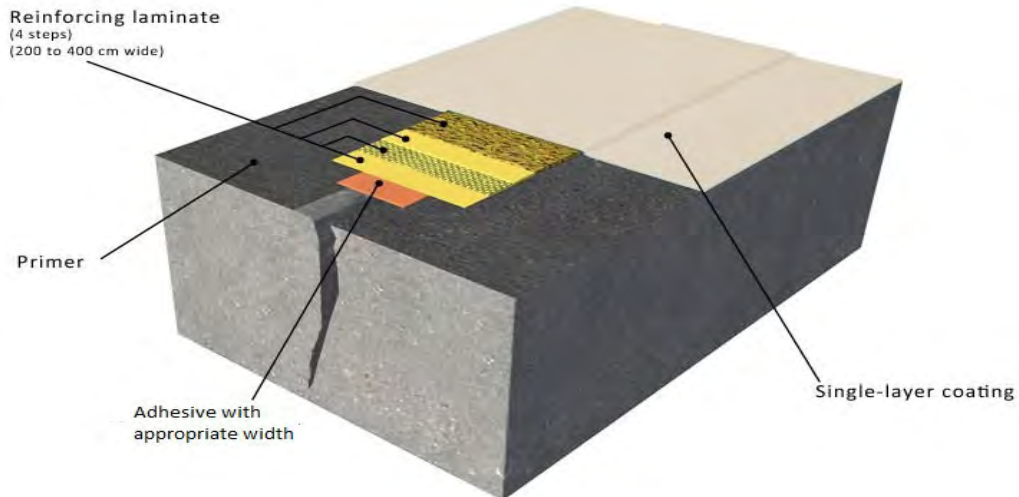

Sketch no.3: Treating a crack when applying a laminate coating

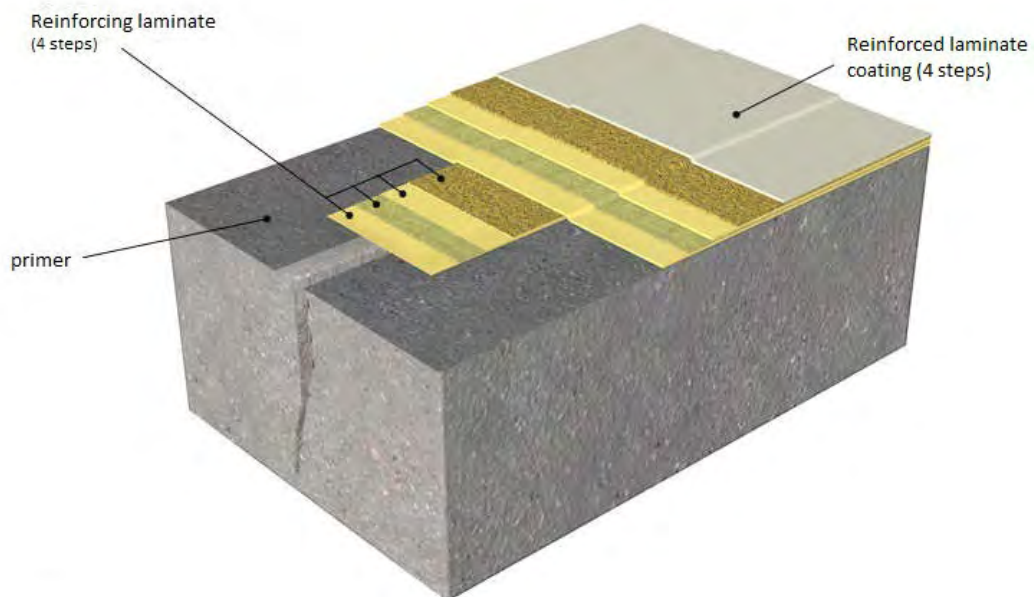

Sketch no.4: Treating an expansion joint or an active and penetrating crack when applying a laminate coating

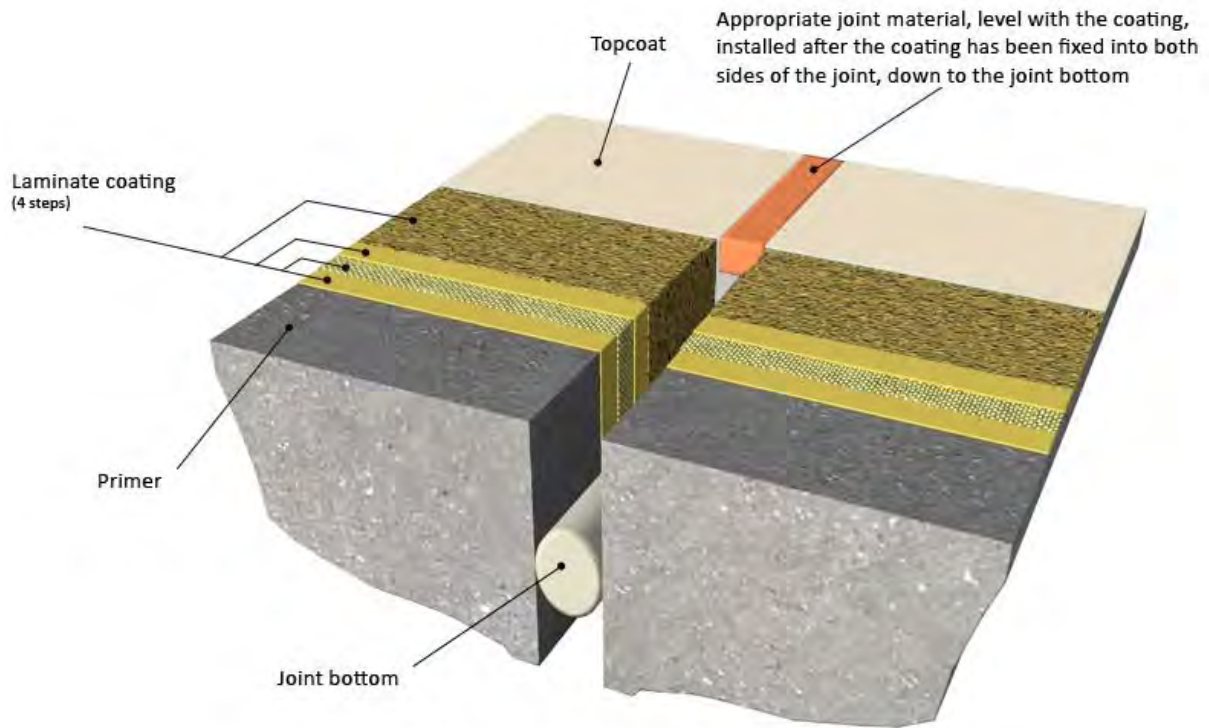

Treatment is the same when applying a single-layer coating

Sketch no.5: Treating a closed angle corner

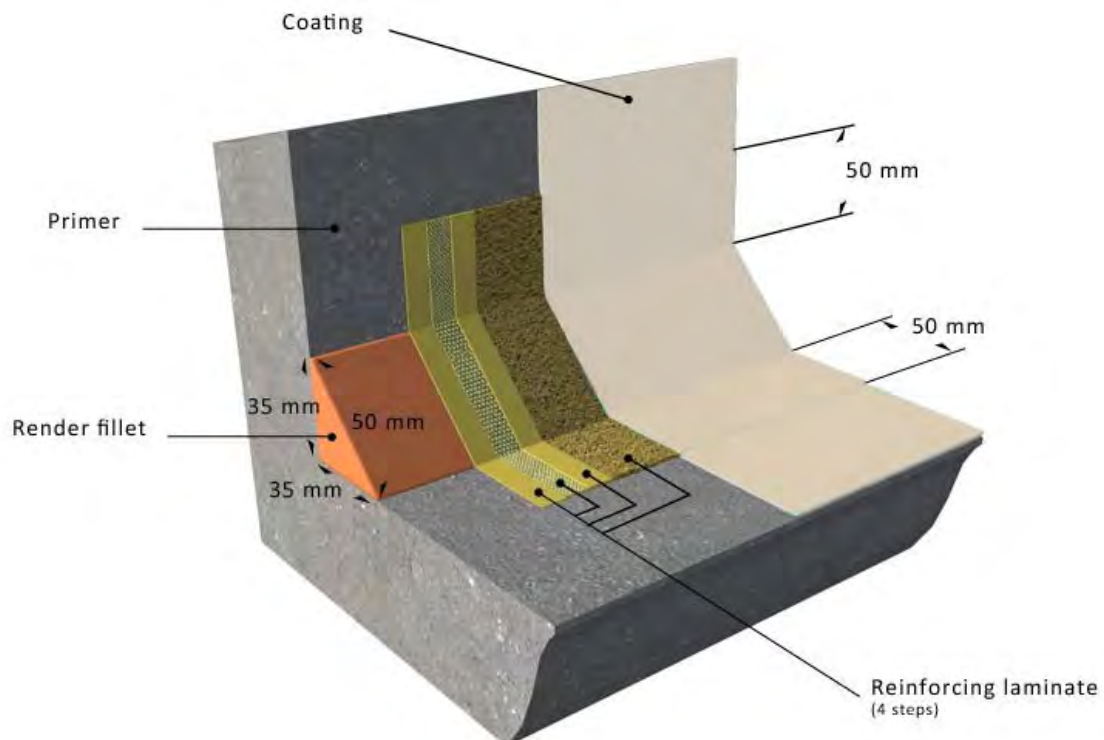

Sketch no.6: Treating an open angle when applying a laminate coating

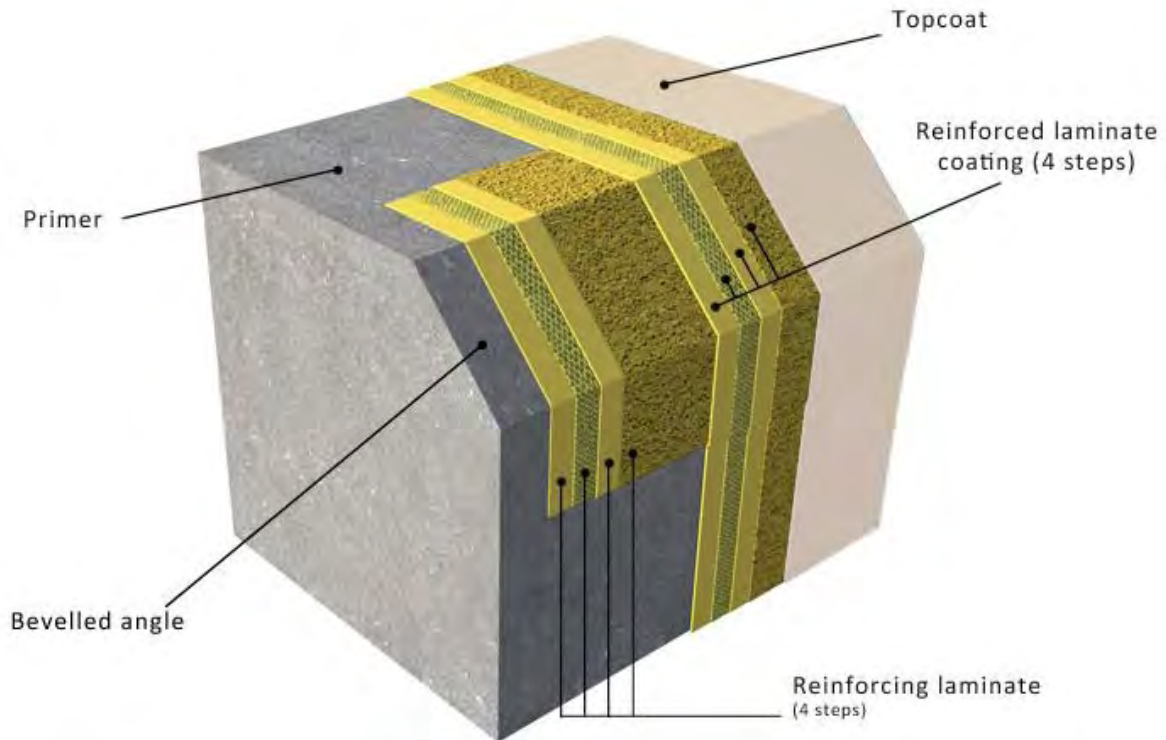

Sketch no.7: Treating an open angle when applying a single-layer coating

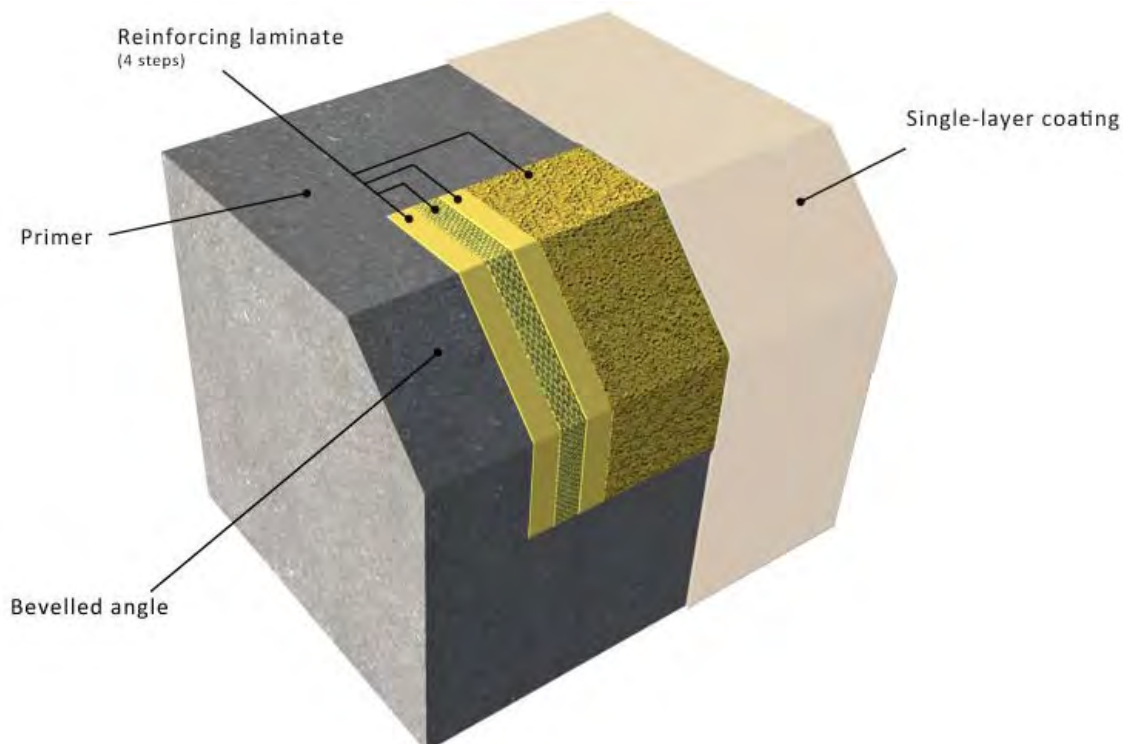

Sketch no.8: Treating an engraving when applying a laminate coating

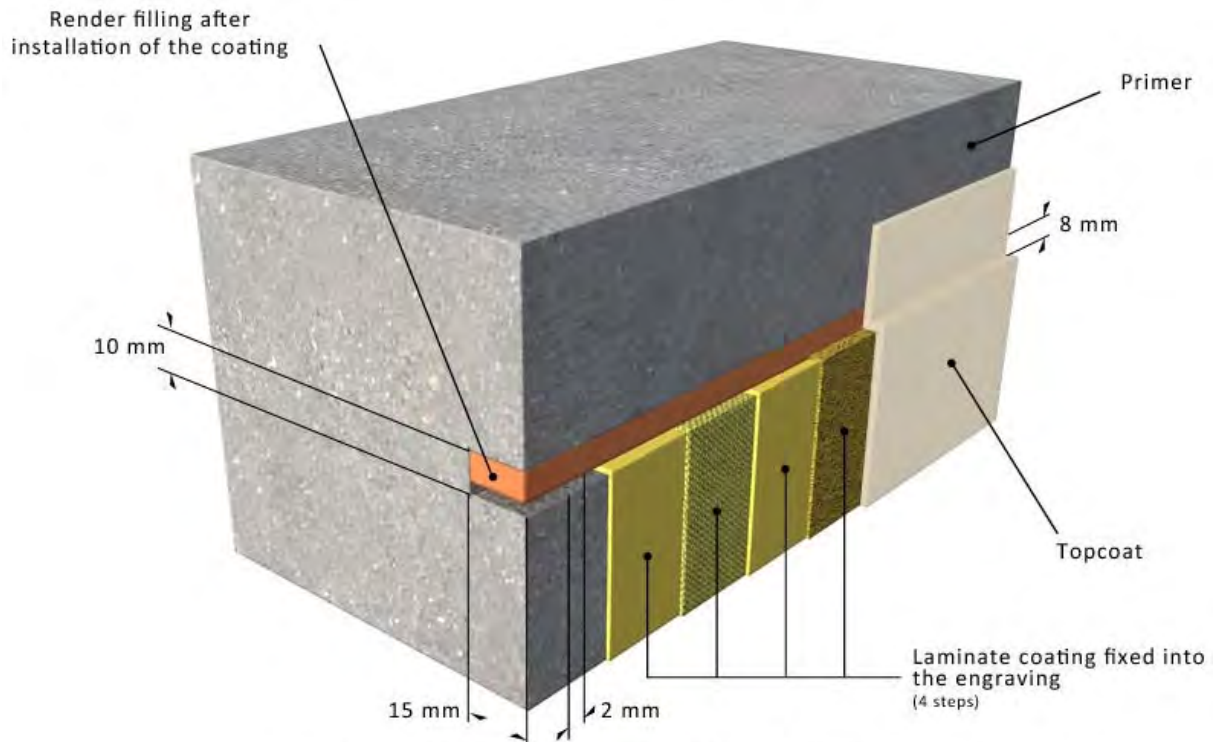

Treatment is the same when applying a single-layer coating

Sketch no.9: Treating an outgoing steel plate

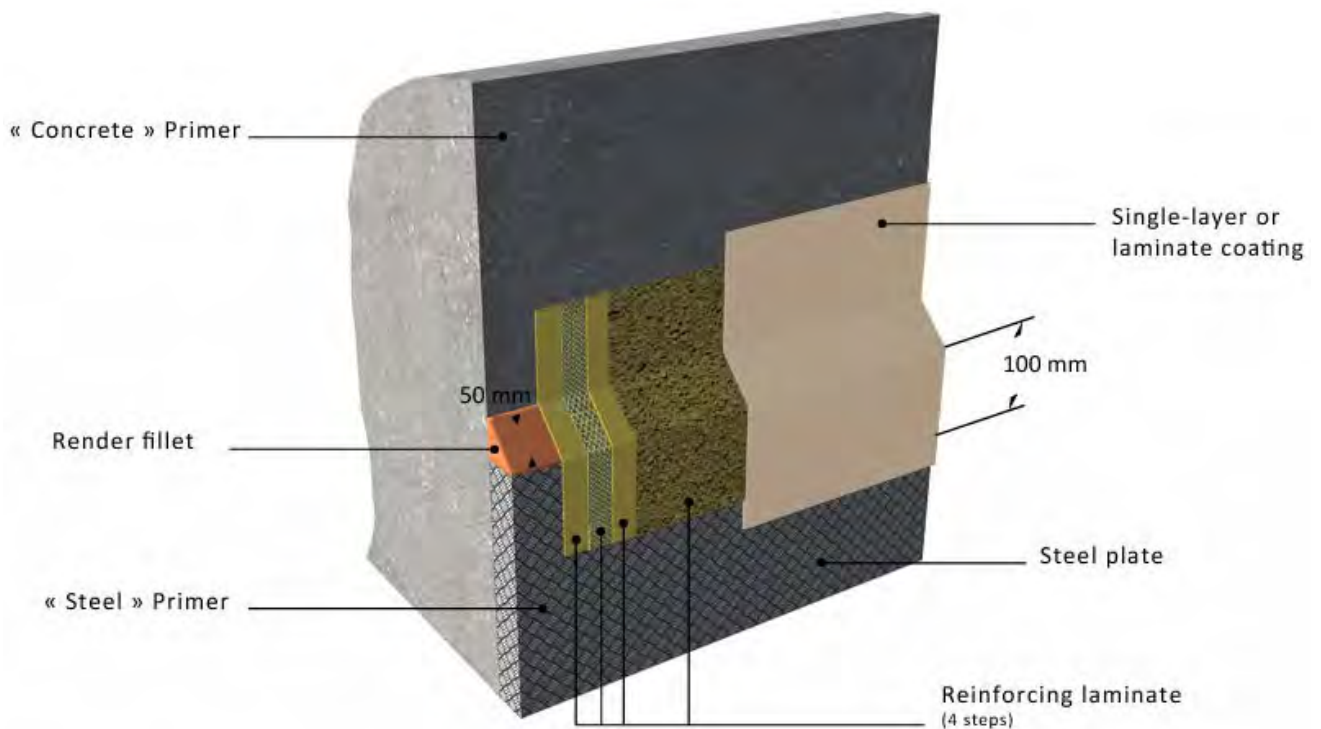

Sketch no.10: Treating an ingoing steel plate

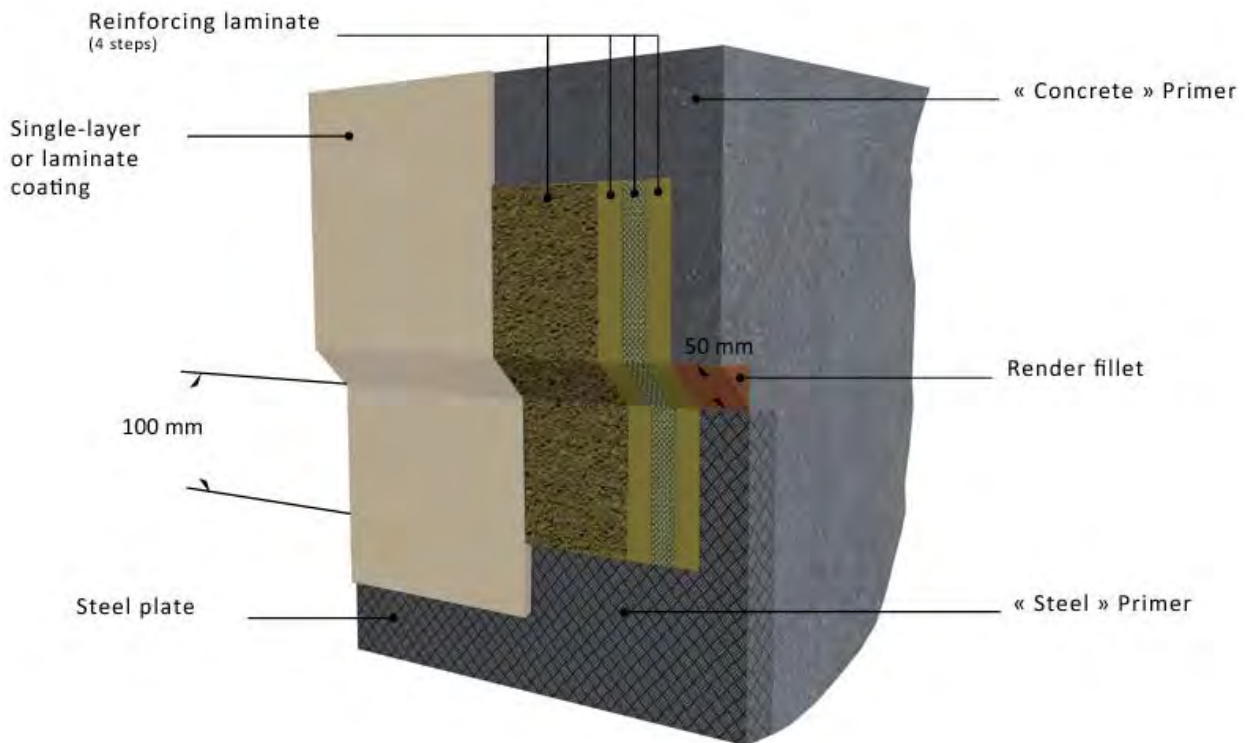

Sketch no.11: Treating an incoming pipe or other penetrating element

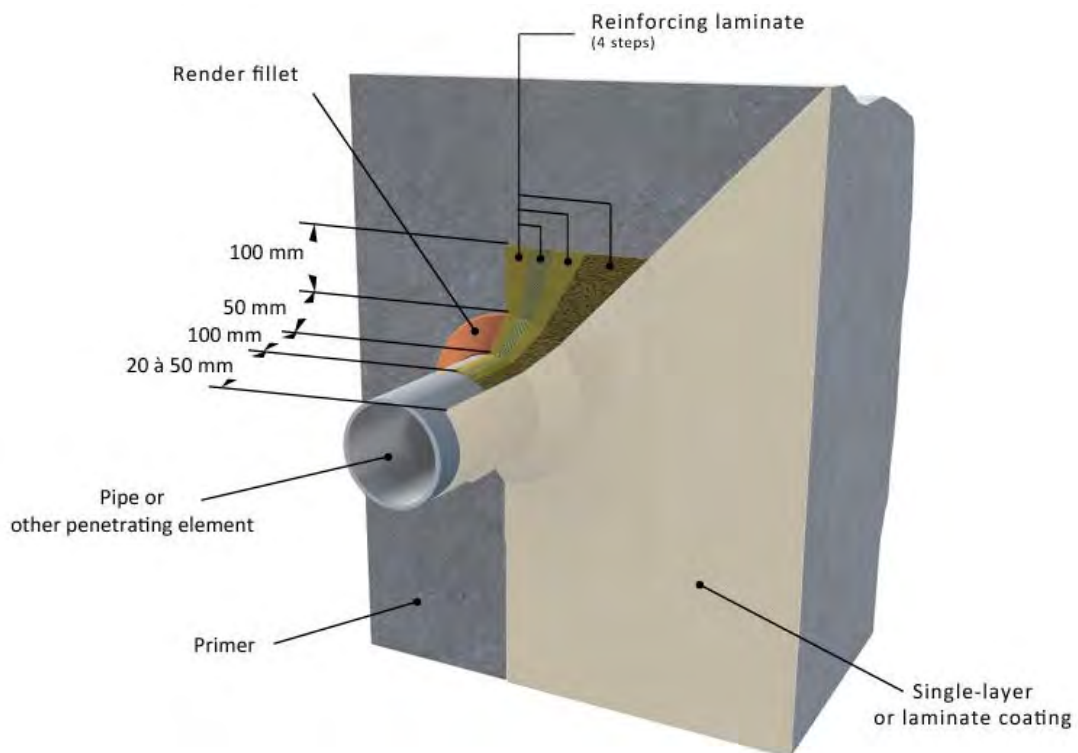

Sketch no.12: Treating a mechanically-fixed (or anchored) coating

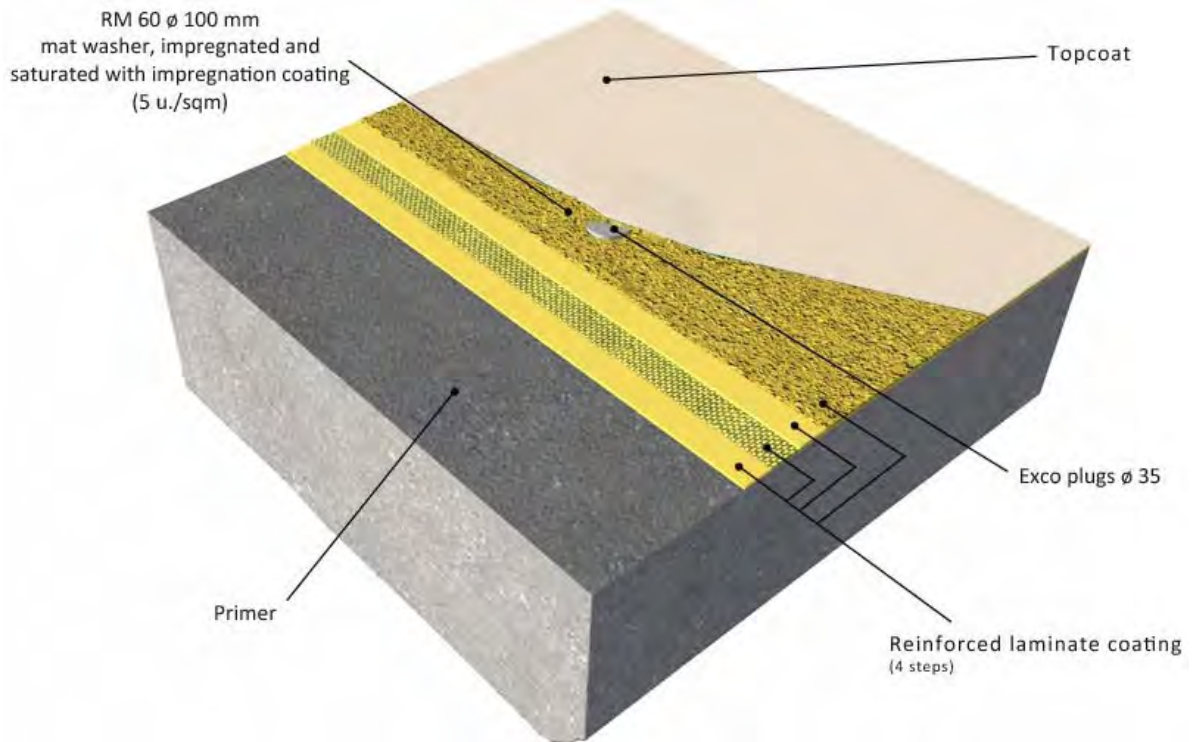

6. Performance testing and retouching

Testing is performed by the application contractor to check the reliability of its work.

Tests take place:

- > during the application
- > after the application.

They are carried out in conformity with the processes described in our *Technical Advice Nr. 3 "Performance Testing"* and *Technical Advice Nr. 4 "Dielectric Testing"* - see appendix 3.

They may lead to repairs or retouches using the *Technical Advice Nr. 5 "Retouching"* – see appendix 3.

7. Technical assistance

It is provided by our **Technical Assistance Department** upon request from the application contractor.

It comprises :

- > theoretical and practical training
- > recapitulating the main implementation phases
- > performing jointly with the application contractor a **"reference zone"** on a representative area.

8. Commissioning

It can take place after a certain waiting time which varies according to the curing time of the coating at different temperatures:

- > 10°C: 10 days
- > 20°C: 7 days
- > 30°C: 4 days
- > 40°C: 3 days

9. Servicing / maintenance / repairs

Refer to the appropriate specific details in the *Technical Advice Nr. 5 "Retouching"* - see appendix 3.

10. Qualification of application companies

They must:

- > either give proof of successful and equivalent experience under similar conditions
- > or have received from us significant training specific to the products to be applied , borne out by the certification of the operators by one of our Technician-trainers .

11. Warranty - modalities and operation :

- Principle of operation:

It operates on the principle described in Chapter 11 of the ITBTP Publication.

- Definition:

This is a **performance guarantee** meaning that the coating implemented is capable of fulfilling the functions of:

- > waterproofing or watertightness of the interior surfaces of a concrete structure
- > protection of the interior surfaces of a steel structure
- > non pollution of the contents, where appropriate, under specified conditions and for a specified time.

- Criteria:

They are studied according to the structure's specific operating parameters.

These criteria are notably:

- > the degree of allowable cracking for the waterproofing or watertightness function
- > possible nature, concentration, pH and temperature of the cleaning/disinfection products.

- Operating mode :

The warranty is jointly agreed to by *max perlès et cie* and the application contractor .

It is materialized in a **Joint guarantee** co-signed by the two parties and handed over to the beneficiary client / building owner.

It stipulates that , in case of a problem , the costs for removing the defective coating and supplying and applying a new coating are covered.

It is covered by an insurance policy taken out by each of the joint parties for its own liability according to the model hereafter .

Waterproof , Watertight and Protective coatings



Insurance Certificate – General Liability

The undersigned, SCOR Europe SE, having its head office at 5 Avenue Kléber - 75 116 Paris - France, hereby certifies that the company:

MAX PERLES et Cie
4 rue du Professeur René Dubos
60119 HENONVILLE

is insured under the policy n° **FA0095300** underwritten with our company in respect of the pecuniary consequences of its civil liability risks that may incur as a result of bodily injury, material and immaterial damage caused to third parties and attributable to the activities insured by this policy.

Activity: Sale of products for the execution of covering work for storage and transport capacities in the field of water and sanitation.

The guarantees of the contract are exercised up to the amounts indicated below:

Combined Insurance limit:

PUBLIC LIABILITY / PRODUCT LIABILITY

ALL DAMAGES COMBINED (bodily injured, property damages & financial losses)**10 M€** per policy period

Including:

- Pure Financial Losses ("D.I.N.C.") with the amount of **5 M€** per year
- "Faute inexcusable de l'employeur" with the amount of **5 M€** per year
- Dismantling/Reinstalling costs with the amount of **5 M€** per year
- Professional liability with the amount of **2.5 M€** per year
- Pollution Sudden and Accidental (classified locations excluded) with the amount of **3 M€** per year
- Damages resulting from exports to the USA/Canada, all damages aggregate (Bodily injuries, Property damages and Financial losses): with the amount of **5 M€** per year
- Including: Pure financial losses ("D.I.N.C.") on "Loss of use" basis with the amount of **1 M€** per year

DEFENSE AND RECOURSE: EUR 30'000 per claim and per year

Limits shown above may have been reduced by paid claims.

The present certificate is certificate is valid for the period from 01/01/2024 to 31/12/2024 inclusive, subject to the payment of the premium, and subject to the possibility of suspension or termination of the policy during the policy period for the cases provided for by the French Insurance Code or the policy.

It is addressed to whom it may concern and cannot bind our company beyond the limits of the clauses and conditions of the policy that it refers to and notably with respect to the activities insured by this policy.

This certificate constitutes only an assumption of coverage. The coverage solely applies within the terms and conditions of the General Third-Party liability policy n° **FA0095300**.

Issued in Paris, 11/01/2024





Waterproof , Watertight and Protective coatings

Appendix 1

SOCOTEC's Conformity Certificate no. 23106808000034

CE marking and Performance Declaration

Origin of the products

Attestation de conformité

MAX PERLES

4 rue du Professeur Dubos
BP 80439
60119 HENONVILLE Cedex

Revêtement d'étanchéité adhérent (REA) type composite adhérent (CAD)

BIOPERL / P45

Fiche système Version Novembre 2023 (10 pages)

Attestation de conformité au CCTG - Fascicule 74

Procédé traditionnel d'étanchéité pour réservoirs en béton ou en maçonnerie

Le présent rapport atteste de la stricte conformité du système et de sa Fiche système, au référentiel de l'annexe 2 du Fascicule 74 pour les ouvrages revendiqués.

Pour rappel, un procédé conforme au Fascicule 74 est considéré comme un procédé traditionnel de réservoir, relevant des Règles de l'Art construction.

Validité : 30/11/2029

N° D'AFFAIRE : 231068080000034

DATE DU RAPPORT : 01/12/2023

NOMBRE DE PAGES : 2

REFERENCE DU RAPPORT : ANC/23/799 AD/AC

Auteur du rapport : Alexis DUBOIS
✉ alexis.dubois@socotec.com

DIRECTION DES SOLUTIONS TECHNIQUES ET DE L'INNOVATION

Immeuble Mirabeau - 5, place des Frères Montgolfier - Guyancourt - CS 20732 - 78182 - Saint-Quentin-en-Yvelines Cedex
Tél : (+33)1.30.12.83.09 - @ : anc@socotec.com

SOCOTEC CONSTRUCTION - S.A.S au capital de 10 000 100 euros – 834 157 513 RCS Versailles
Siège social : 5, place des Frères Montgolfier- CS 20732 – Guyancourt - 78182 St-Quentin-en-Yvelines Cedex - FRANCE
www.socotec.fr

1. OBJET

La Société MAX PERLES a demandé à SOCOTEC Construction, dans le cadre de la mission définie par le contrat n° 231068080000034, de vérifier la conformité du revêtement d'étanchéité adhérent (REA) type composite adhérent (CAD) BIOPERL / P45 et de sa Fiche système, au Fascicule 74 (version 4.01 mai 2021).
Pour ce faire, l'ensemble des éléments de preuve nécessaires a été transmis à SOCOTEC Construction.

La présente attestation de conformité ne vise que la Fiche système dont la référence figure en page de garde, à l'exclusion de tout autre document.

En particulier, elle ne concerne pas le ou les document(s) de mise en œuvre dont dispose l'industriel pour son système (Cahier des charges, Cahier de mise en œuvre, Fiche Technique, etc...).

Toute mise à jour de la Fiche système rend caduque la présente Attestation de conformité, qui est indissociable de la référence de Fiche système figurant en page de garde.

La diffusion de la présente Attestation de conformité est indissociable de celle de la Fiche Système concernée.

La présente vérification de conformité du procédé à son référentiel n'est pas une certification produit et ne comprend pas de vérification de la constance de la qualité de fabrication.

2. CONCLUSION

Concernant le revêtement d'étanchéité adhérent (REA) type composite adhérent (CAD) BIOPERL / P45 - Fiche système version Novembre 2023, SOCOTEC Construction atteste, par le présent rapport, de :

- La conformité des caractéristiques du revêtement au référentiel de l'annexe 2 du Fascicule 74, pour les ouvrages revendiqués.
- La cohérence de la Fiche système avec les justificatifs du procédé.

Le présent rapport permet donc aux intervenants SOCOTEC Construction, dans l'exercice de leur mission de Contrôle Technique, de considérer comme traditionnel le procédé eu égard au Fascicule 74, dans les limites d'emploi précisées dans la Fiche système.

La date de validité de la présente Attestation de conformité est le 30/11/2029.



Alexis DUBOIS
Expert Technique National
Etanchéité de toiture - Couverture - Cuvelage - Réservoir



**Max
Perlès**
revêtements techniques industriels

DECLARATION DES PERFORMANCES

1	7	1	2	0	0	1
---	---	---	---	---	---	---

Mise à jour

<i>Révision</i>	<i>Date</i>	<i>Rédaction</i>	<i>Approbation</i>
A	14/12/17	F. TAILLIBERT	F. MUTEAU
B	17/12/18	F. TAILLIBERT	F. MUTEAU
C	17/12/20	F. TAILLIBERT	F. MUTEAU
E	10/01/2022	V.DOUVRIN 	F. MUTEAU 

EN 1504-2

1. Code d'identification unique du produit type :	BIOPERL – Système 1
2. Usage(s) prévu(s) :	Produit de protection de surface du béton. Revêtement à base de résine époxy Norme EN 1504-2 : 2005 Principes : 1, 2, 8 Méthodes : 1.3, 2.2, 8.2
3. Fabricant :	Max Perlès et Cie 4 rue du Professeur Dubos 60119 Hénonville
4. Mandataire :	Non applicable
5. Système d'Evaluation et de Vérification de la Constance des Performances :	Système 2+
6. a) Norme harmonisée Organisme notifié :	NF EN 1504-2 Avril 2005 1164 CERIB
6. b) Document d'évaluation européen : Evaluation technique européenne :	Non applicable Non applicable

7. Performances déclarées

Caractéristiques essentielles	Performances	Spécifications techniques harmonisées
Résistance à l'abrasion NF EN ISO 5470-1	PND	EN 1504-2 Avril 2005
Perméabilité au CO ₂ : NF EN 1062-6	S _D > 50 m	
Perméabilité à la vapeur d'eau : NF EN ISO 7783-2	Classe II	
Absorption capillaire et perméabilité à l'eau : NF EN 1062-3	W < 0,1 kg/ (m ² x h ^{0,5})	
Résistance aux chocs : NF EN ISO 6272-1	PND	
Adhérence par traction : NF EN 1542	≥ 2.0 MPa	

8. Déclaration

Les performances du produit identifié ci-dessus sont conformes aux performances déclarées conformément au règlement (U.E) n° 305/2011, la présente déclaration des performances est établie sous la seule responsabilité du fabricant mentionné ci-dessus.

Signé pour le fabricant et en son nom par :

Vanessa Douvrin
Responsable QHSE

Environnement, Santé et Sécurité (REACH)

Une fiche de donnée de sécurité est établie pour ce produit conformément à l'article 31 du règlement REACH. Elle est disponible sur le site www.quickfds.fr.

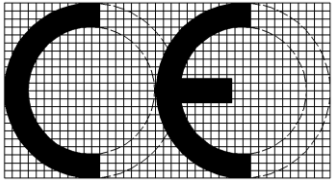
Primaire EDO – Bioperl T Max Perlès – 4 rue du professeur Dubos – BP 80439 – 60119 Hénonville
17
1164-CPR-PPR008 EN 1504-2 : 2005 DOP : 17.12.001
Produits de protection de surface Revêtement
Perméabilité au CO ₂ : NF EN 1062-6 : S _D > 50 m
Perméabilité à la vapeur d'eau : NF EN ISO 7783-2 : Classe II
Absorption capillaire et perméabilité à l'eau : NF EN 1062-3 : W < 0,1 kg / (m ² x h ^{0,5})
Adhérence NF EN 1542 Pour système rigide avec trafic ≥ 2,0 MPa



**Max
Perlès**
revêtements techniques industriels

DECLARATION DES PERFORMANCES

2	0	1	1	0	0	1
---	---	---	---	---	---	---

Mise à jour

<i>Révision</i>	<i>Date</i>	<i>Rédaction</i>	<i>Approbation</i>
A	28 nov. 2020	F. TAILLIBERT	F. MUTEAU
B	17 déc. 20	F. TAILLIBERT	F. MUTEAU
C	10 janv. 22	V. DOUVRIN 	F. MUTEAU 

EN 1504-2

1. Code d'identification unique du produit type :	BIOPERL – Système 2
2. Usage(s) prévu(s) :	Produit de protection de surface du béton. Revêtement à base de résine époxy Norme EN 1504-2 : 2005 Principes : 1, 2, 8 Méthodes : 1.3, 2.2, 8.2
3. Fabricant :	Max Perlès et Cie 4 rue du Professeur Dubos 60119 Hénonville
4. Mandataire :	Non applicable
5. Système d'Evaluation et de Vérification de la Constance des Performances :	Système 2+
6. a) Norme harmonisée Organisme notifié :	NF EN 1504-2 Avril 2005 1164 CERIB
6. b) Document d'évaluation européen : Evaluation technique européenne :	Non applicable Non applicable

7. Performances déclarées

Caractéristiques essentielles	Performances	Spécifications techniques harmonisées
Résistance à l'abrasion NF EN ISO 5470-1	PND	EN 1504-2 Avril 2005
Perméabilité au CO ₂ : NF EN 1062-6	S _D > 50 m	
Perméabilité à la vapeur d'eau : NF EN ISO 7783-2	Classe II	
Absorption capillaire et perméabilité à l'eau : NF EN 1062-3	W < 0,1 kg/ (m ² x h ^{0,5})	
Résistance aux chocs : NF EN ISO 6272-1	PND	
Adhérence par traction : NF EN 1542	≥ 2.0 MPa	

8. Déclaration

Les performances du produit identifié ci-dessus sont conformes aux performances déclarées conformément au règlement (U.E) n° 305/2011, la présente déclaration des performances est établie sous la seule responsabilité du fabricant mentionné ci-dessus.

Signé pour le fabricant et en son nom par :

Vanessa Douvrin
Responsable QHSE

Environnement, Santé et Sécurité (REACH)

Une fiche de donnée de sécurité est établie pour ce produit conformément à l'article 31 du règlement REACH. Elle est disponible sur le site www.quickfds.fr.

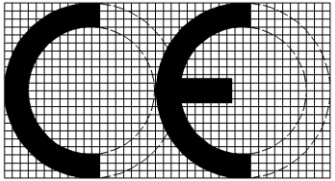
<p>SCREENPERL – BIOPERL T Max Perlès – 4 rue du professeur Dubos – BP 80439 – 60119 Hénonville</p>
<p>20</p>
<p>1164-CPR-PPR008 EN 1504-2 : 2005 DOP : 20.11.001</p>
<p>Produits de protection de surface Revêtement</p>
<p>Perméabilité au CO₂ : NF EN 1062-6 : S_D > 50 m</p>
<p>Perméabilité à la vapeur d'eau : NF EN ISO 7783-2 : Classe II</p>
<p>Absorption capillaire et perméabilité à l'eau : NF EN 1062-3 : W < 0,1 kg/ (m² x h^{0,5})</p>
<p>Adhérence NF EN 1542 Pour système rigide avec trafic ≥ 2,0 MPa</p>

Origin of the products

Design and manufacture :

They are designed and manufactured in our plant at Hénonville, Oise, France, under a Quality System conforming to ISO 9001 version 2015 and certified by Bureau Veritas Certification France under nr. FR067169-1.

Labelling/packaging/storage :

Packaging includes in particular the following indications:

- > risk and safety phrases and logos:
- > manufacture date
- > shelf life
- > storage conditions
- > mixing proportions



Waterproof , Watertight and Protective coatings

Appendix 2

Product Technical Data Sheets

EDO PRIMER
SCREENPERL®

AR100 RENDER

BIOPERL®
GELCOAT SV101

FIBERGLASS FABRICS P45, P80, P120



**Max
Perlès**
advanced industrial coatings

data sheet

April 2022

Primer

EDO

waterborne epoxy

scope:

concrete preparation

CHARACTERISTICS

Description / purpose

Where: On concrete or under our epoxy systems.

What: Improving adhesion and wetting ability for our epoxy systems.

Reducing or even stopping of water infiltrations before coating.

Primer EDO is a component of two systems that carry a **CE Marking** and are adapted for the following protection situations: principle 1, method 1.3; principle 2, method 2.2 and principle 8, method 8.2 of Norm NF EN 1504-2.

Colour / finish

Clear / satin.

Packaging

In 2 separate cans, pre-adjusted for 8 kg.

Proportions, *by weight*: base **385** / hardener **615**.

Storage conditions

- 18 months max, in the original cans, never opened,
- Under shelter,
- At temperatures of between 1°C/34°F and 35°C/95°F ⁽¹⁾.

V.O.C. content

0 g/l according to ISO 11890-1 (statistic average).

Composition

Resin: epoxide Pigments: none
Hardener: polyamide Vehicle: water

Specific gravity (mix) at 20°C/68°F

1.20 ± 0.05 g/ml as per ISO 2811

Solids content (mix)

By weight : 47 % ± 2 as per ISO 3251

By volume : 36 % per calculation

Viscosity (mix) at 20°C/68°F

Fluid.

⁽¹⁾ which might increase or decrease by 10°C/50°F, once only, during a 5 days max transport time to destination.

IMPLEMENTATION

For all use:

refer to relevant material safety data sheets indicating risk sentences and safety recommendations

Surface preparation

Concrete free from oil, laitance and dust.

Possible application on damp but non sweating surface.

Instructions for use

- **Air temperature for application:**

Substrate: 3°C/37°F above dewpoint,
with 5°C/41°F at least ♦ 45°C/113°F at most.

Product: 5°C/41°F mini ♦ 35°C/95°F maxi.

- **Reducing viscosity when temp. <15°C/60°F:** add 10% water to the hardener *prior to mixing with the base*.

- **Mix:** Pour *the base into hardener* while carefully stirring mechanically until a perfectly homogeneous mixture is obtained.

- **Maturing:** none.

- **Potlife mixture** at 20°C/68°F: 2 hours ⁽²⁾

- **Application:** roller or brush, exclusively.

⁽²⁾ The limit shows when a separation of phases becomes visible on the surface, producing a "turned" mix effect.

Consumption / thickness

- 250 g/sqm in a single coat. EDO being an impregnation material, no specific thickness is required.
- 2, even 3 coats should be applied when lasting dampness on the substrate or in case of infiltration risks.

Curing at 10°C/50°F – 30°C/86°F

- Dust free: 6 and 3 hours
- Recoatable: mini: 6 and 3 hours ♦ maxi: none

Make sure of absence of humidity before recoating.

Precautions and safety

Waterborne product. Flash point (cc) : >100°C/212°F

Cleaning of application equipment

- Immediately after use : water
 - Afterwards and up to 3 hours standby :
- Flammable ED Thinner – Flash point (cc) : 25°C/77°F.

ISO 9001 certified since 1996

4 rue du Professeur Dubos – BP 80439 – 60119 Hénonville Cedex (France) – Tel : 33 (0) 3 44 49 86 22 – Fax: 33 (0) 3 44 49 85 00 – Web: www.maxperles.com

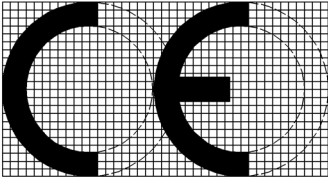
<p>Primaire EDO – Aquaperl T Max Perlès – 4 rue du professeur Dubos – BP 80439 – 60119 Hénonville</p>
<p>16</p>
<p>1164-CPR-PPR008 EN 1504-2 : 2005 DOP : 16.08.001</p>
<p>Produits de protection de surface Revêtement</p>
<p>Perméabilité au CO₂ : NF EN 1062-6 : S_D > 50 m</p>
<p>Perméabilité à la vapeur d'eau : NF EN ISO 7783-2 : Classe II</p>
<p>Absorption capillaire et perméabilité à l'eau : NF EN 1062-3 : W < 0,1 kg/ (m² x h^{0,5})</p>
<p>Adhérence NF EN 1542 Pour système rigide avec trafic ≥ 2,0 MPa</p>

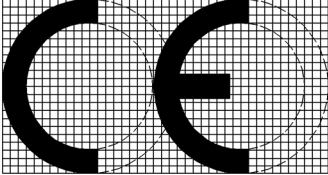
<p>Primaire EDO – Bioperl T Max Perlès – 4 rue du professeur Dubos – BP 80439 – 60119 Hénonville</p>
<p>17</p>
<p>1164-CPR-PPR008 EN 1504-2 : 2005 DOP : 17.12.001</p>
<p>Produits de protection de surface Revêtement</p>
<p>Perméabilité au CO₂ : NF EN 1062-6 : S_D > 50 m</p>
<p>Perméabilité à la vapeur d'eau : NF EN ISO 7783-2 : Classe II</p>
<p>Absorption capillaire et perméabilité à l'eau : NF EN 1062-3 : W < 0,1 kg / (m² x h^{0,5})</p>
<p>Adhérence NF EN 1542 Pour système rigide avec trafic ≥ 2,0 MPa</p>



**Max
Perlès**
advanced industrial coatings

data sheet

October 2023

SCREENPERL®

conductive epoxy primer, solvent-free

*scope:
surface treatment*

CHARACTERISTICS

Description / purpose

Where: On concrete or metal , under our epoxy coatings.

What: Conductive primer guaranteeing homogeneous “holiday” (porosity) testing of the watertightness of the coating above. It also blocks the surface porosity of concrete substrates and resists a high degree of counterpressure through the concrete in the case of underground structures.

Colour / finish

Black / glossy.

Packaging

In 2 separate cans, pre-adjusted for 8 kg.

Proportion, *by weight*: base **60** / hardener **40**.

Storage conditions

- 18 months max, in the original cans, never opened,
- Under shelter,
- At temperatures of between 5°C/32°F and 35°C/95°F.

V.O.C. content

42 g/l (maximum), according to ISO 11890-1 (P1-M2).

Properties and benefits

SCREENPERL also provides a high degree of adherence to a concrete substrate (CSTB test R2EM-SIST-19-26078323) thereby resisting to capillary and osmotic blistering (CSTB test R2EM-SIST-18-26075428).

Composition

Resin: epoxide
Hardener: polyamine
Pigments: carbonated

Specific gravity (mix) at 20°C/68°F

1.05 ± 0.05 g/ml as per ISO 2811

Solids content (mix)

By weight : 96-100% after 6 hrs maturation - ISO 3251
By volume : 100 % per calculation

Viscosity (mix) at 20°C/68°F

36 Poises ± 4 poises.

Electrical resistivity (by volume) :

10⁶ Ω/sq as per ASTM D257.

APPLICATION

For all uses:

refer to relevant material safety data sheets indicating risk sentences and safety recommendations

Surface preparation

Concrete free of oil, laitance and dust.

Steel: after smoothing of sharp edges, abrasive-blasted surfaces to Sa 2.5 standard, Medium G or Rt 50-75µm.

Products preparation

24 hours minimum before application, place the cans in a temperate area at 10°C/50°F min and 30°C/86°F max.

Application temperatures

Ambient temperature: 5°C to 35°C

Relative humidity: below 85%

Substrate temperature: 5°C to 35°C and 3°C minimum above dewpoint (on concrete)

Product:

While mixing: 10°C /50°F mini ♦ 30°C/86°C maxi

Manual use : at mixing temperature

Mixing

- **Never make up partial mixtures**, in order to avoid the risks of incorrect proportions.
- Stir the base with a power mixer to an even consistency. Then add hardener and continue stirring until a perfectly homogeneous mixture is obtained.

Conditions for use

- No maturing before use.
- Start the application immediately after mixing.
- **SCREENPERL® should never be diluted.**

Application

- roller or brush.

Pot-life of mixture

10°C/50°F	20°C/68°F	30°C/86°F
2 h 00	0 h 35	0 h 10

Consumption

- **Concrete** : 250 g to 300g /sqm . Can be higher if porosity of the concrete surface is high.
- **Steel** : 80±15 g/sqm for 75µm dry film thickness

Curing

t°	Dust Free	Tack free	Overcoatable (mini-maxi)
10°C	-	-	10 h 00 -30 days
20°C	3 h 00	24 h 00	4 h 00 -15 days
30°C	-	-	2 h 00 -3 days

Precautions and safety

Solvent-free. Flash point (cf) : >100°C/212°F

Cleaning of application equipment

Flammable ED Thinner – Flash point (cf) : 25°C/77°F.

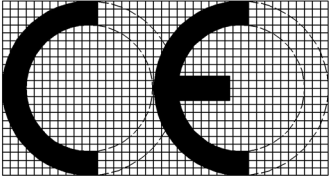
<p>SCREENPERL – BIOPERL T Max Perlès – 4 rue du professeur Dubos – BP 80439 – 60119 Hénonville</p>
<p>20</p>
<p>1164-CPR-PPR008 EN 1504-2 : 2005 DOP : 20.11.001</p>
<p>Produits de protection de surface Revêtement</p>
<p>Perméabilité au CO₂ : NF EN 1062-6 : S_D > 50 m</p>
<p>Perméabilité à la vapeur d'eau : NF EN ISO 7783-2 : Classe II</p>
<p>Absorption capillaire et perméabilité à l'eau : NF EN 1062-3 : W < 0,1 kg/ (m² x h^{0,5})</p>
<p>Adhérence NF EN 1542 Pour système rigide avec trafic ≥ 2,0 MPa</p>



**Max
Perlès**
advanced industrial coatings

data sheet

October 2023

Render
AR100

solventfree epoxy

scope:
*concrete and steel
surface preparation*

OVERVIEW

Purpose

Where: Under our epoxy coating systems or under other chemically-compatible coatings.

What: Surfacing, rendering, filling cavities and joints, creating chamfers.

Which: Steel or concrete structures.

Description

Product : Solventfree epoxy, CMR's free,

Use : Light or heavy local or complete rendering and filling, creation of chamfers in angles. Thicknesses up to 30mm. Vertical or horizontal.

Properties and benefits

Mechanical properties :

Exceptional adhesion and sticking properties, with very high mechanical cohesion.

Usage properties :

RENDER AR100 is easy to use and multi-purpose. It requires neither sanding nor grinding.

Compliance with safety and regulatory requirements:

RENDER AR100 is **solventfree**, flash point (cc): > 90°C/194°F

for optimal safety and minimized application constraints. It is **aromatic amines and phthalates free** for compliance with current regulations.

CHARACTERISTICS

Packaging

- In 2 separate cans, pre-adjusted for 4 or 12 kg.
- Proportion *by weight*: base **85** / hardener **15**

Storage conditions

- 18 months max, in the original cans, never opened,
- Under shelter,
- At temperatures of between 5°C/32°F and 35°C/95°F⁽¹⁾,
⁽¹⁾ which might increase or decrease by 10°C/50°F, once only during a 5 days max transport time to destination.

Colours

Yellow ochre, approaching RAL 8001.

Finish

Semi-mat.

V.O.C. content

17.7 g/l, according to ISO 11890-1 (statistic average).

Composition

Resin	:	epoxide
Hardener	:	non aromatic polyamine
Pigments	:	synthetic oxides
Filler	:	silicates/silica
Solvent	:	none

Specific gravity (mix) at 20°C/68°F

1.90 ± 0,05 g/ml as per ISO 2811

Solids content (mix)

By weight : 96–100% after 6 hrs maturation - ISO 3251
By volume : 100% per calculation

Viscosity (mix) at 20°C/68°F

Pasty.

APPLICATION

Conforming and controlled conditions during application and hardening periods are necessary to obtain required quality

For all uses :
Refer to relevant material safety data sheets as to risk sentences and safety recommendations

◆ Before:

Surface preparation

Concrete impregnated with **PRIMER EDO**, **AQUAPRIM** or **SCREENPERL®** :

Refer to relevant data sheets and *Technical Advice nr 1* : « Specification for preparation of concrete ».

Steel : after smoothing of sharp edges, abrasive blasted surfaces to Sa 2,5 minimum. Average profile :

- In case of application of **ED1 VARNISH**, **AQUAPRIM** or **SCREENPERL®** primers (see data sheets) :
Medium G or Rt 50-75µ.

- In case of direct application : Rough G or Rt 100µ.

Always apply on clean and dry substrates

Products preparation

24 hours minimum before application, place the cans in a temperate area at 10°C/50°F min and 30°C/86°F max.

Application temperatures

Ambient temperature: 5°C to 35°C

Relative humidity: below 85%

Substrate temperature: 5°C to 35°C and 3°C minimum above dewpoint,

Product:

While mixing: 10°C /50°F mini ◆ 30°C/86°C maxi

Use : at mixing temperature

Mixing

- *Never make up partial mixtures*, in order to avoid the risks of incorrect proportions.
- Stir the base with a power mixer to an even consistency. Then add hardener and continue stirring until a perfectly homogeneous mixture is obtained.

Conditions for use

- No maturing before use.
- Start the application immediately after mixing.
- **RENDER AR100 should never be diluted.**

Application conditions

- Manual : Palette knife, spatula or trowel.
- Mechanically : Pump for paste-like product, or pneumatic double cartridge caulking gun with a static mixer

◆ During:

Potlife of mixture

10°C/50°F	20°C/68°F	30°C/86°F
4 h 00	2 h 00	1 h 00

Consumption / thickness per mm

1,9 kg/sqm.

This theoretical value should be increased by **10±5%** for practical consumption,, according to the nature of the substrate and the application.

Note:

Consumption will increase when surface temperature is < 20°C, making the product viscous.

Overcoating

No minimum or maximum delay after application and no particular prior conditions, except in the following case: if thickness is > 5 mm, or in the care of smoothing, there may be a rise of epoxy resin to the surface.

In this case it is necessary :

- either to sprinkle **SILICA SB0** or **F15** on the surface, while progressing,
- or to sand paper the surface, after at least 12/24 hours' drying according to temperature, in order to obtain a Rough G surface roughness.

◆ After:

Curing

t°	Dust free	Tack free
10°C	8 to 9 h 00	24 h 00
20°C	5 to 6 h 00	15 to 18 h 00
30°C	2 to 2 h 30	5 to to 6 h 00

Cleaning of application equipment

Flammable ED Thinner. Flash point (cc): 25°C/77°F.



**Max
Perlès**
advanced industrial coatings

data sheet

October 2023

BIOPERL®

« cold applied » solventfree epoxy coating

scope:
waste waters and salt waters

OVERVIEW

Purpose

Where: Internal protection of digesters, decanters, reservoirs and basins, mud storage, flocculation, coagulation and filtration tanks, sewage pumping stations, gutters and sewage pipes, salt and brackish water storage, in waste water treatment plants and desalination plants.

What: contact with domestic and industrial waste waters and gases, sea and brackish waters.

Which: Steel or concrete structures.

Description

Designed to supply a long-lasting solution for the internal protection and waterproofing of concrete and steel civil works either as a multi-layer, glass-fiber-reinforced coating capable of resisting a certain degree of future cracking in a concrete substrate, or as a single-layer coating on concrete or steel, that will guarantee the long-term protection of the concrete or steel substrate.

Use:

BIOPERL®R: Impregnation/saturation of glass-fiber reinforcements

BIOPERL® T: Top or single coat, from 500 to 1000µ thickness

BIOPERL® conforms to European Norm NF EN 1504-2 « Systems for the surface protection of concrete »

A copy of the declaration of performances 1712001 of Bioperl® – system 1 made up EDO Primer and Bioperl® T topcoat is available on request.

A copy of the declaration of performances 2011001 of Bioperl® – system 2 made up Screenperl® and Bioperl® T topcoat is available on request.

Properties and benefits

Chemical performance:

- Permeability to oxygen/resistance to H₂S:
LNE « oxygen transmission coefficient measurement » test report nr P137771 – Document DE/2
- Very good inertia to waste waters, greases, detergents, salt waters and diluted bases and acids.

Mechanical performance:

High, as shown in GINGER CEBTP tests report numbers BEB6.H.3035, BEB6.M.3028, BEB6.K.3058, BEB6.N.3009, BEB6.K.3018

Surface properties:

Aspect : uniform and seamless glossy surface.
Result : very easy to clean, no weak areas.

Compliance with safety and regulatory requirements:

BIOPERL® is **solventfree**, flash point (cc): > 90°C/194°F for optimal safety and minimized application constraints. It is **aromatic amines or phthalates free** for compliance with current regulations.

CHARACTERISTICS

Packaging

- In 2 separate cans, pre-adjusted: **R:** for 12 kg
T: for 12 kg
- Proportion, *by weight*: base **3** / hardener **1**

Storage conditions

- 18 months max, in the original cans, never opened,
- Under shelter,
- At temperatures between 5°C/32°F and 35°C/95°F⁽¹⁾,
⁽¹⁾ which might increase or decrease by 10°C/50°F, once only during a 5 days max transport time to destination.

Colours

R/T: Light ochre.

Finish

Glossy with limited chalking and yellowing in operation.

Reinforcements

Please consult us.

V.O.C. content

R : 7.7 g/l, according to ISO 11890-1 (statistical average)
T : 12.7 g/l, according to ISO 11890-1 (statistical average)

Composition

Resin : epoxy
Hardener : non-aromatic polyamine
Pigments : synthetic oxides
Solvent : none

Specific gravity (mix) at 20°C/68°F

R/T : 1.32 ± 0.05 g/ml as per ISO 2811

Solids content (mix)

By weight : 96–100% after 6 hrs maturation - ISO 3251
By volume : 100% per calculation

Viscosity (mix) at 20°C/68°F

R : 4 500 mPa.s ± 1 000 ◆ 45 poises ± 10
T : 6 000 mPa.s ± 1 000 ◆ 60 poises ± 10

ISO 9001 certified since 1996

4 rue du Professeur Dubos – BP 80439 – 60119 Hénonville Cedex (France) – Tel : 33 (0) 3 44 49 86 22 – Web: www.maxperles.com

APPLICATION

Conforming and controlled conditions
During application and hardening periods
Are necessary to obtain required quality

For all uses:
Refer to relevant material safety data sheets as to
risk sentences and safety recommendations

◆ Before:

Surface preparation

Concrete impregnated with **PRIMER EDO** or **SCREENPERL®**:
Refer to relevant data sheet and *Technical Advice nr1*
« Specification for preparation of concrete ».

Steel after smoothing sharp edges, abrasive blasted
surfaces to Sa 2.5 degree. Average profile:

- In case of prior application of **SCREENPERL®** (see data sheet):
Medium G or Rt 50-75µ.

- In case of direct application: Rough G or Rt 100µ.

Always apply on clean and dry substrates

Products preparation

24 hours minimum before application, place the drums in a
temperate area at 10°C/50°F min and 30°C/86°F max.

Application temperatures

Ambient temperature: 5°C to 35°C

Relative humidity: below 85%

Substrate temperature: 5°C to 35°C and 3°C minimum above
dewpoint (on concrete)

Product:

While mixing: 10°C/50°F mini ◆ 30°C/86°C maxi

Spraying : at 30/35°C // 86/95°F at hose exit

Manual use : at mixing temperature

Mixing

- *Never make up partial mixtures*, in order to avoid the
risks of incorrect proportions.

- Stir the base with a power mixer to an even consistency.
Then add hardener and continue stirring until a perfectly
homogeneous mixture is obtained.

Conditions for use

- No maturing before use.
- Start the application immediately after mixing.
- **BIOPERL® should never be diluted.**

Application

BIOPERL R:

Medium bristle roller, or 45:1 airless pump

Debubbler roller for the glass fiber,

Mechanical sprinkling of Silica SB 0 before drying.

Detailed procedure is described in our *Technical Advice nr 14*
available on request.

BIOPERL T:

- Airless spraying unit, with a 45/1 min pump ratio, fitted
with heating hose.

- Or medium bristle roller, for small or difficult to access areas,
as long as particular attention is paid to the thickness and
regularity of applied coat. This shall be followed by smoothing
the surface with a flat brush.

◆ During:

Pot life of mixture

Grades	10°C/50°F	20°C/68°F	30°C/86°F
R	3 h 15	1 h 10	0 h 30
T	2 h 15	0 h 40	0 h 10

In case of long-lasting spraying application, the hose should
be cleaned every hour with ED Thinner.

Number of passes

2 per coat, except in the case of multi-layer continuous
application, and 1 for topcoat and singlecoat.

Thicknesses

BIOPERL R:

They depend on the system specified and the thickness of
the glass-fiber reinforcement specified but are generally
comprised between 2.0 and 3.0 mm, including a 600µ
topcoat.

BIOPERL T:

Min 500 microns – max 1000 microns, according to system
specified.

Consumption

BIOPERL R:

- 1,4 kg/sqm for a P45 fabric-450 g/sqm : 1,5 mm
- 1,8 kg/sqm for a P80 fabric-800 g/ sqm : 2,0 mm
- 2,2 kg/sqm for a P120 fabric-1200 g/ sqm : 2,5 mm

BIOPERL T:

132 g/sqm per 100 microns thickness.

This theoretical value should be increased by **15±5%** for
practical consumption, according to the nature of the
substrate and the application.

Note:

Consumption will increase of 100 to 300 g/sqm when surface
temperature is < 20°C, making the product viscous.

Cleaning of application equipment

Flammable ED Thinner. Flash point (cc): 25°C/77°F.

◆ After:

Curing

t°	Dust free	Tack free
10°C	R: 10 h 00 – T: 4 h 00	R: 26 h 00 – T: 12 h 00
20°C	R: 6 h 00 – T: 3 h 00	R: 16 h 00 – T: 10 h 00
30°C	R: 2 h 30 – T: 1 h 30	R: 7 h 00 – T: 4 h 00

Delay before use: 10, 7 or 4 days, depending on ambient
temperature.

Repairs

Report to our *Technical Advice nr 5.*

2/3

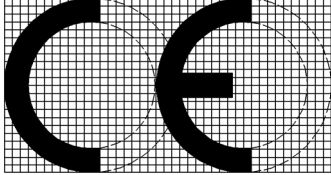
Primaire EDO – Bioperl T Max Perlès – 4 rue du professeur Dubos – BP 80439 – 60119 Hénonville
17
1164-CPR-PPR008 EN 1504-2 : 2005 DOP : 17.12.001
Produits de protection de surface Revêtement
Perméabilité au CO ₂ : NF EN 1062-6 : S _D > 50 m
Perméabilité à la vapeur d'eau : NF EN ISO 7783-2 : Classe II
Absorption capillaire et perméabilité à l'eau : NF EN 1062-3 : W < 0,1 kg / (m ² x h ^{0,5})
Adhérence NF EN 1542 Pour système rigide avec trafic ≥ 2,0 MPa

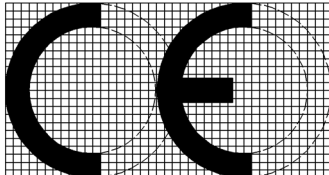
SCREENPERL – BIOPERL T Max Perlès – 4 rue du professeur Dubos – BP 80439 – 60119 Hénonville
20
1164-CPR-PPR008 EN 1504-2 : 2005 DOP : 20.11.001
Produits de protection de surface Revêtement
Perméabilité au CO ₂ : NF EN 1062-6 : S _D > 50 m
Perméabilité à la vapeur d'eau : NF EN ISO 7783-2 : Classe II
Absorption capillaire et perméabilité à l'eau : NF EN 1062-3 : W < 0,1 kg / (m ² x h ^{0,5})
Adhérence NF EN 1542 Pour système rigide avec trafic ≥ 2,0 MPa



**Max
Perlès**
advanced industrial coatings

data sheet

November 2023

fiberglass tissue

P45

Biaxial glass fabric – 450 g/sqm

scope:
*reinforcement of our epoxy
coatings*

OVERVIEW

Description

Glass tissue, made of two cloths of woven glass fibers oriented at + and – 45°, attached to a glass mat, and with a **black** longitudinal thread to indicate the width of recommended overlapping.

Purpose

Reinforcement of epoxy coatings, particularly to obtain resistance to future cracking in a concrete substrate.

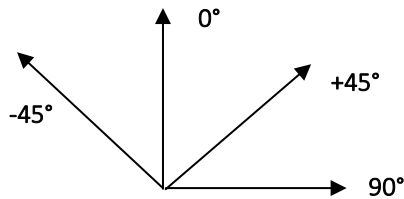

Properties and benefits

- High mechanical performance.
- Excellent drapability.
- No longitudinal deformation.
- Easy to roll-out, impregnate and saturate.

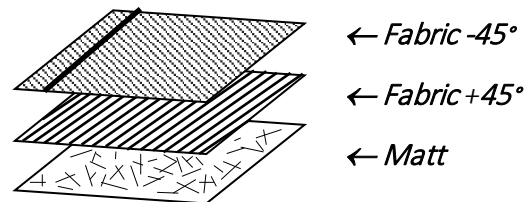

CHARACTERISTICS

Specifications

Axis angle	Weight (g/sqm)	Tolerance	Fiber	Filament diameter	Finish
Fabric +45°	187	± 5%	E-glass	12 - 14 μ	Silane
Fabric -45°	187	± 5%	E-glass	12 - 14 μ	Silane
Matt	100	± 5%	E-glass	-	-
Sewing	<10	± 5%	PE	78 dTex	-

Dimensions of the rolls

Length: about 40 lm
Width: 127 cm
Weight: about 25 kg
Surface: about 51 sqm
Also exists in the form of a 20cm-wide band, 79lm long: **R45**

Thickness

500μ.

Packaging

On a cardboard mandrel, with the matt on the outside, in a polyethylene bag.

Storage conditions

Must not be exposed to moisture.

Store in a dry atmosphere (humidity below 90%), under shelter, in the original packing, at a temperature of between 5°C/32°F and 35°C/95°F.

Use conditions

Use in a non-condensing environment and on a non-condensing substrate, as per our [Technical Advice nr14](#).

Replaces and cancels any former issue - The above mentioned information is given with objectiveness but cannot involve our company beyond our manufacturer's responsibility.

ISO 9001 certified since 1996

4 rue du Professeur Dubos – BP 80439 – 60119 Hénonville Cedex (France) – Tél : 33 (0) 3 44 49 86 22 – Web : www.maxperles.com

© All rights reserved – 2023 as per article L122-4. Any full or partial representation or reproduction made without our express written consent is illegal. It is the same for the translation, the adaptation or the transformation, the arrangement or the reproduction by any art or any process.



**Max
Perlès**
advanced industrial coatings

data sheet

November 2023

fiberglass tissue

P80

Biaxial glass fabric – 800 g/sqm

scope:
*reinforcement of our epoxy
coatings*

OVERVIEW

Description

Glass tissue, made of two cloths of woven glass fibers oriented at + and – 45°, attached to a glass matt, and with a *green* longitudinal thread to indicate the width of recommended overlapping.

Purpose

Reinforcement of epoxy coatings, particularly to obtain resistance to future cracking in a concrete substrate.

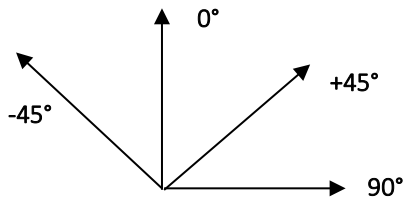

Properties and benefits

- High mechanical performance.
- Excellent drapability.
- No longitudinal deformation.
- Easy to roll-out, impregnate and saturate.

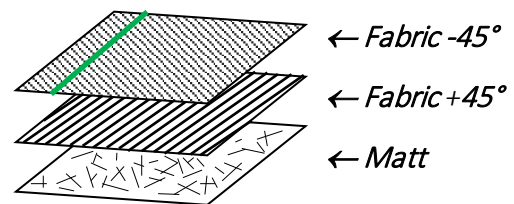

CHARACTERISTICS

Specifications

Axis angle	Weight (g/sqm)	Tolerance	Fiber	Filament diameter	Finish
Fabric +45°	350	± 5%	E-glass	12 - 16 μ	Silane
Fabric -45°	350	± 5%	E-glass	12 - 16 μ	Silane
Matt	100	± 5%	E-glass	-	-
Sewing	<10	± 5%	PE	78 dTex	-

Dimensions of the rolls

Length: about 24 ml
Width: 127 cm
Weight: about 25 kg
Surface: about 31 sqm

Thickness

800μ

Packaging

On a cardboard mandrel, with the matt on the outside, in a polyethylene bag.

Storage conditions

Must not be exposed to moisture.

Store in a dry atmosphere (humidity below 90%), under shelter, in the original packing, at a temperature of between 5°C/32°F and 35°C/95°F.

Use conditions

Use in a non-condensing environment and on a non-condensing substrate, as per our *Technical Advice nr14*.

Replaces and cancels any former issue - The above mentioned information is given with objectiveness but cannot involve our company beyond our manufacturer's responsibility.

ISO 9001 certified since 1996

4 rue du Professeur Dubos – BP 80439 – 60119 Hénonville Cedex (France) – Tél : 33 (0) 3 44 49 86 22 – Web : www.maxperles.com

© All rights reserved – 2023 as per article L122-4. Any full or partial representation or reproduction made without our express written consent is illegal. It is the same for the translation, the adaptation or the transformation, the arrangement or the reproduction by any art or any process.



**Max
Perlès**
advanced industrial coatings

data sheet

March 2022

Gelcoat
SV101

solventfree novolac epoxy

scopes:
*chemical industry
and energy*

OVERVIEW

Purpose

Where: Internal protection of tanks, retention pits, gutters.

What: Occasional or permanent contact with effluents, which may be radioactive or not, acid or basic, in energy production sites or chemical industries.

Which: Steel or concrete structures.

Description

Product: solventfree epoxy-novolac, C.M.R.'s free.

Use:

- either as a direct single coat,
- either as a topcoat of an epoxy-fibre reinforced structure such as one of the « **perl** » range.

Typical thickness: according to specification: from 500 to 800 microns.

Application in one vertical coat: up to 500µ with an airless pump, or 300µ with a roller.

Properties and benefits

Chemical and nuclear performance:

Exceptional inertia to a very large number of mineral and organic acids at ambient temperature: please consult us.

Decontamination test: report nr 06/07 by CEA Saclay.

Application properties:

To take advantage of a simple and cost effective standard spraying machine.

Surface properties:

Aspect : uniform and seamless glossy surface.

Result : very easy to clean, no weak areas.

Compliance with safety and regulatory requirements:

SV101 is solventfree, flash point (cc): > 90°C/194°F for optimal safety and minimized application constraints.

It is **aromatic amines, phthalates and styrene free** for compliance with current regulations.

CHARACTERISTICS

Packaging

- In 2 separate cans, pre-adjusted for 12 kg.
- Proportions, *by weight*: base **1** / hardener **1**

Storage conditions

- 18 months max, in the original cans, never opened,
- Under shelter,
- At temperatures of between 0°C/32°F and 35°C/95°F⁽¹⁾,
⁽¹⁾ which might increase or decrease by 10°C/50°F, once only during a 5 days max transport time to destination.

Colours

Beige, approaching RAL 1015.

Finish

Glossy with limited chalking and yellowing in operation, *especially if implementation requirements are respected.*

Reinforcements

Please consult us.

V.O.C. content

52 g/l (maximum), according to ISO 11890-1 (P1-M2)

Composition

Resin : novolac-epoxy
Hardener : non-aromatic polyamine
Pigments : synthetic oxides
Solvent : none

Specific gravity (mix) at 20°C/68°F

1.30 ± 0.05 g/ml as per ISO 2811

Solids content (mix)

By weight : 96–100% after 6 hrs maturation - ISO 3251
By volume : 100% per calculation

Viscosity (mix) at 20°C/68°F

6 000 mPa.s ± 1 000 ◆ 60 poises ± 10

A slight evolution may happen during the storage period, without any effect on the application conditions.

IMPLEMENTATION

Conform and controlled conditions
During application and hardening periods
Are necessary to obtain required quality

For all use:
Refer to relevant material safety data sheets as to
risk sentences and safety recommendations

◆ Before:

Surface preparation

Steel after sharp edges have been smoothed, on abrasive blasted surfaces to Sa3 degree.

Average profile:

- In case of prior application of **Varnish ED1** or **Primer EDA** (see data sheet):

Medium G or Rt 50-75µ.

- In case of direct application:

Rough G or Rt 100µ.

Our epoxy **laminates**, according to specification.

On specific recommendation: **concrete** impregnated with **EDO**, **EDA Primer** or **Screenperl®**: please consult us.

Always apply on clean and dry substrates

Products preparation

24 hours minimum before application, place the cans in a temperate area at 10°C/50°F min and 30°C/86°F max.

Application temperatures

Substrate:

3°C/37°F minimum above dew point,

With: 5°C/41°F at least ◆ 45°C/113°F at most.

Product:

While mixing: 10°C/50°F min ◆ 30°C/86°F max

Spraying at: 25°C/77°F min at hose exit

Manual use: at mixing temperature

Mixing

- *Never make up partial mixtures*, in order to avoid the risks of incorrect proportions.
- Stir the base with a power mixer to an even consistency. Then, add hardener and continue stirring until a perfectly homogeneous mixture is obtained.

Conditions for use

- No maturing before use.
- Start the application immediately after mixing.
- **Gelcoat SV101 should never be diluted.**

Application

- Airless spraying unit, with a 45/l min pump ratio, fitted with heating hose.
- Or medium bristle roller, *in 2 passes*, with an interval of 2 to 6 hours between both at 20°C, *each one to be followed by smoothing the surface with a flat brush.*

During:

Pot-life of mixture

10°C/50°F	20°C/68°F	30°C/86°F
2 h 00	0 h 30	0 h 10

In case of long lasting spraying application, the hose should be cleaned once per hour with ED Thinner.

Number of coats

Horizontal application: 1

Vertical application: 2, *within the acceptable recoating interval*: see below.

Recommended thickness

500 to 800 microns, according to specification.

Thicknesses are proposed in agreement with the method of the International standard ISO 19840:

Do not exceed 30% above the maximum value, except for pre-touchups and local overcoatings.

Theoretical consumption

130 g/sqm per 100 microns thickness.

This theoretical value should be **20±5 % increased** to get it practical, according to nature of substrate and implementation method.

Note:

Consumption will increase of 100 to 300 g/sqm when surface temperature is < 20°C, making the product viscous with its contact.

Cleaning of application equipment

Thinner ED. Flammable product. Flash point (cf): 25°C.

◆ After:

Curing

t°	Dustfree	Recoatable
10°C	5 h 00	min 5 h 00 – max 8 h 00
20°C	2 h 00	min 2 h 00 – max 6 h 00
30°C	1 h 00	min 1 h 00 – max 3 h 00

Delay before use: 10, 7 or 4 days, depending on temperature.

Repairs

Report to our *Technical Advice nr 5*.

Appendix 3

Technical Advices

Technical Advice No. 1

“Specification for preparation of concrete”

Technical Advice No. 2

“Specification for preparation of steel substates”

Technical Advice No. 3

“Performance testing”

Technical Advice No. 4

“Dielectric testing”

Technical Advice No. 5

“Retouching”

Technical Advice No. 7

“Engraving of a laminate”

Technical Advice No. 14

“Application of fiberglass/epoxy laminates”



**Max
Perlès**
advanced industrial coatings

Specification for preparation of concrete

Scope :

This document describes:

- the necessary requirements, in terms of substrate surface condition, to undertake coating work, new or remedial.
- the products to use and measures to take if such requirements are not fulfilled.
- the sequence of steps to implement.

It does not cover the structural state or strength of the concrete substrate, which is presumed to comply with all applicable norms, rules and regulations (see list at the beginning of our Technical Manuals).

Requirements :

Drying of new or refurbished substrates :

- New concrete:
28 days minimum, depending on temperature and ventilation.
- Mortars and water based renders:
Refer to the indications provided in the manufacturer's relevant product data sheet.

Substrate aspect :

- Uniform and smooth, free of sharp edges and/or cavities exceeding 0.5 mm from the average level. The profile must have a roughness of between CSP 3 to 5 of concrete surface profiles according to the ICRI (International Concrete Repair Institute).
- The air holes in fresh concrete must be filled up when the casing is released, without yielding a glossy surface.

Laitance :

Is absolutely prohibited, as are pure cement finishes.

Substrate cleanliness:

- Casing release agents and additives must be eliminated.
- Substrate must be free of loose particles and of any pollutants such as paint, oil, grease and wax – which would be harmful to the adherence of the coating. It must be vacuum cleaned very carefully to eliminate dust .

Water infiltration and counter-pressure:

Install drainage solutions or apply specific treatment – see following page .

Substrate reconditioning to fulfil these requirements :

Implementation conditions:

Make sure the ambient conditions for each operation are in accordance with the relevant product data sheets.

Presence of laps, edges, scrapes, etc:

Grind off and vacuum the dust.

Light laitance, traces of pure cement, oil and other pollutants:

Lightly clean off, using fine grade abrasives with limited pressure or light waterjet. Vacuum the dust and/or dry off.

Thick laitance, pure cement finish, fresh cast concrete:

Carefully sandblast using fine grade abrasives with limited pressure, or adapted waterjet. Vacuum the dust and/or dry off.

Repair :

Mortars and other products used for the repair of the concrete must be chemically compatible with Max Perlès coatings , must be fast-setting and checked against the risk of them creating a difference in potential between old and new concrete parts .

Apparent steel reinforcement must be passivated before being covered over : carefully brush off loose oxydes and passivate using our modified epoxy PRIMER W.

Dry substrate:

Impregnate with one coat of EDO PRIMER or of SCREENPERL®, waterborne epoxy.

Double the coat in case of high porosity.

Damp substrate:

Impregnate with one coat of EDO PRIMER or of SCREENPERL®, in order to neutralize moisture. To be repeated two or three times in case of moisture re-sweating.

Air holes in cast concrete / coarse trowelling:

The surface must be rendered with our AR100 RENDER, a solvent-free epoxy charged with silica, in one or two coats.

Damaged surface with deep cavities:

Fill with AR100 RENDER, in successive passes up to 2 cm thick each, after adding in silica F15, if necessary, to constitute a mortar (up to 1 for 1 in weight).

Stabilized cracks (*) and passive concrete overlaps:

- Bridge them over with a 5 to 10 cm wide plasticized adhesive tape
- Then reinforce them:
 - by applying a fiberglass fabric strip 20 cm wide, saturated with the appropriate Max Perlès epoxy resin and sprinkled while progressing with SB0 SILICA SAND, when under a single-layer watertight coating
 - by implementing the fully-adherent multi-layer coating system directly in the case of waterproofing.

Un-stabilized cracks (*) and active concrete overlaps:

As above, adapting the width of the bridging as well as the nature and weight of the local or general reinforcement according to the width of the crack.

(*) according to French standard NFP 95-103.

Sequence :

- ◆ Grinding
- ◆ Blasting
- ◆ Dust removal
- ◆ EDO PRIMER or SCREENPERL®
- ◆ AR100 RENDER
- ◆ Bridging/reinforcement
- ◆ Coating

Particular case :

Counter-pressure:

Can be accepted, in the case of a reinforced waterproof coating, for a value of up to 0.5 MPa (5 bar). Value obtained according intern method CEBTP.

Specification for preparation of steel

Scope

This document describes:

- the necessary requirements, in terms of substrate surface conditions, to undertake coating work, new or remedial.
- the products to use and measures to take if such requirements are not fulfilled.

It does not cover the structural state or strength of the steel substrate, which is presumed to comply with all applicable norms, rules and regulations.

Requirements

Preparation of sheet steel :

Must be to degree P2 as per standard NF EN ISO 8501-3.

- Barbs, scratches or weld projections must be eliminated by chipping and grinding.
- Sharp edges and weld beads must be rounded by grinding.

Environmental conditions:

- **All coating work must be undertaken at ambient temperature within the range indicated in the product data sheet of the chosen coating.**

Appropriate air heating or, symmetrically, air cooling and ventilation equipment must be used if necessary.

Work in cold weather on an open air surface is not recommended.

- **Always operate at a difference of at least +3°C / + 38°F between the measured temperature of the steel substrate and the dew point – see standard NF EN ISO 8502-4.**

Use appropriate air heating, or deshydration equipment if necessary.

ISO 12944 recommendations should be applied.

Blasting:

- **Before:** if using solid abrasive material, check that it is of appropriate quality and not damp, check that the blasting equipment is operational and that air pressure at the nozzle is sufficient to cover pressure losses.
- **Implementation:** by sand blasting or hydro blasting or combined blasting until the profile and the roughness specified in our system sheet is obtained.
- **After:** vacuum-dust very carefully and eliminate all abrasive deposits, including those on the scaffolding.

The residual dust content on the steel surface is measured according to ISO 8502-3 and must not exceed category 2.

The soluble salt content on the steel surface is measured according to ISO 8502-6 and 9 and must be lower than 50 mg/sqm.

Primer:

Immediately after blasting and before any re-oxidation, apply a 30 microns dry film thickness stand-by coat of Varnish ED1 or Primer EDA, colorless epoxies, unless our specification stipulates direct application of the coating on the blasted steel.

Specific points

Sheet holes:

Before applying the coating, fill all holes and craters with Render AR100, solventfree epoxy.

Floating roof tank strut supports:

After blasting and prior to any coating, screw struts one by one and stick in place 5 mm thick prefabricated reinforced epoxy plates using Render AR100.

Pre-cut to a size slightly smaller than the one of the metallic reinforcement plates which may exist.



**Max
Perlès**
advanced industrial coatings

Technical Advice Nr.3

August 2019

Performance testing

Scope

This document describes the tests that must be done to carry out the reliability of the coating implementation.

They take place: . **during** the application,
. **after** the application.

Testing during application

- **Environmental conditions:**

While progressing with humidity and temperature recording devices, placed and moved depending on work progress to ensure at all times that the dew point is not reached and the temperature ranges are met.

- **Wet film thickness:**

At each coat, using a **calibrated** notched gauge, while progressing and at least once every sqm.

- **Consumption:**

It is complementary to the thickness test and detects any possible discrepancy in real time.

- **Aspect :**

Permanent verification that bubbles or "pinholes" do not appear and that the film presents a uniform and homogeneous surface.

Testing after application:

- **Dry film thickness on metallic surfaces:**

After physical "drying", using a magnetic sensor device, calibrated under the conditions defined by the standard ISO 19840.

- **Polymerization:**

After 48 hours minimum (at 20°C // 68°F), by a test, with white cotton rubbed once on the film onto which a few drops of acetone were deposited: cotton should not show any trace of the coating colour.

- **Porosities:**

Verification of the coating's dielectric sealing following the method described in our *Technical Advice nr.4* "Dielectric testing" by sweeping all the coated surfaces with an electrical brush adapted to the substrate.

In case of linings reinforced with fiberglass fabric, this test is carried out on the laminate before topcoat is applied.

If the laminate is implemented on an old supposedly insulating coating, it is necessary to apply a coat of conducting interface beforehand: ref. Interface CF.

It is also possible to test the topcoat independently if a coat of the same Interface CF has been applied between the two layers.

Please consult us.

Repairs:

If necessary, all tests must be followed by the appropriate corrective actions:

– immediately, if tests are carried out during the application

or

– as described in our *Technical Advice nr.5* then re-tested in case of tests carried out after application.

Replaces and cancels any former issue

The above mentioned information is given with objectiveness but cannot involve our company beyond our manufacturer's responsibility.

ISO 9001 certified since 1996

4 rue du Professeur Dubos – BP 80439 – 60119 Hénonville Cedex (France) – Tél : 33 (0) 3 44 49 86 22 – Fax : 33 (0) 3 44 49 85 00 – Web : www.maxperles.com



**Max
Perlès**
advanced industrial coatings

Dielectric testing

Scope

This document describes the operation to be carried out to detect perforations, porosities, micro-cracks, conductive inclusions or other defects in a waterproof coating, whether applied on concrete or on steel. It is termed dielectric testing or holiday detection .

Principle

With the substrate connected to ground, test the integrity of the coating by sweeping its surface with a continuously powered “brush” or “broom” probe:

A **bluish electric arc and a distinct drop in voltage** occurs in case of porosity, perforation or conductive inclusion in the coating, accompanied by a **sharp audible signal**.

Note: When this control is done on a multi-layer coating, a yellowish glow may be observed, accompanied by a continuous buzz of the device. This phenomenon is not in itself indicative of the presence of a porosity.

Conditions

Time limit :

Dielectric testing should be performed at least 48 hours (when ambient temperature is around 20°C / 68°F) or 72 hours (at around 15°C / 60°F) after coating application.

If the coating is multi-layer, glass-tissue reinforced this test is carried out on the coating before the topcoat (finishing coat) is applied.

If the coating is being applied on a previously-existing , supposedly insulating coating, it is necessary to apply a coat of our conductive SCREENPERL® coating onto the old coating before proceeding with the new coating.

Equipment

ELCOMETER or similar.

Steps

1. Connect the equipment to ground using the ground wire

2. Power up and test the charge

3. Calibrate the equipment:

On concrete or steel substrates :

Apply the brush or broom to the surface of bare concrete or of bare metal and progressively increase the voltage until an audible and luminous error signal is obtained. ***The value indicated at this point is considered as the tare, and must be added to the control voltage defined by the coating thickness – see NF EN ISO 29601 standard and paragraph 4 below.***

4. Set the equipment to the appropriate voltage:

Film thickness:	Test voltage:
0,5 mm	2,9 kVolts + tare
1,0 mm	5,5 kVolts + tare
1,5 mm	8,5 kVolts + tare
2,0 mm	11,7 kVolts + tare
3,0 mm	17,0 kVolts + tare
4,0 mm	22,5 kVolts + tare

5. Perform the dielectric testing :

After checking that ***the coating surface is dry and clean***, the operation is carried out at a constant speed of about 5 linear meters/min :

- with a broom for large flat surfaces
- with a brush for corners and in areas with irregular profile.

If the voltage indicated by the equipment drops to a value close to the tare value (or drops by at least two thirds of the set voltage) and the bluish arc appears together with the sharp audible signal, this indicates the presence of perforations, porosities or conductive inclusions in the coating.

Defects detected this way are marked out for later repairs as per our [Technical Advice nr.5](#). Once corrected, they too will be tested using the same process.

Replaces and cancels any former issue

The above mentioned information is given with objectiveness but cannot involve our company beyond our manufacturer's responsibility.

ISO 9001 certified since 1996



**Max
Perlès**
advanced industrial coatings

Technical Advice

Nr.5

August 2019

Retouching

Scope

This document describes the steps to carry out localized repairs in the following cases:

- Correction, after polymerization of the coating, of areas showing porosity, appearance or hardness defects, insufficient thickness, etc.
- Repair of accidental mechanical or chemical damages.
- Reinstating the watertightness of the coating when it has been drilled through by chemical plugging to install equipment fittings.

Implementation conditions

Environmental conditions, including temperature and humidity, must be those specified in the relevant product data sheets.

Surface preparation

- **Clearly delimitate** the areas to be repaired by surrounding them with adhesive tape at a distance of 5cm from the damaged or faulty spot.
- **Totally eliminate** the coating inside the delimited area, back to the substrate, by grinding.
- **Re-create** the same roughness as originally both on the bared substrate and on the adjacent undamaged areas, using appropriate mechanical means, in order to provide optimum adhesion of the new coating.

Cleaning

Must be done on all prepared areas, ensuring elimination of pollution, dust or heterogeneous particles.

Retouching

Use the same coating products as initially implemented, under the same conditions.

- **In the case of an originally airless-sprayed topcoat or single coat :**

- **homogeneous or open surfaces:**

Apply the new coating using the same machine/pump as originally, after having protected the surrounding surfaces in order to avoid the deposit of spray mist or "overspray" which can cause surface roughness which, in turn, would complicate ulterior cleaning operations and reduce the sanitary characteristics of the coating.

- **small or difficult to access surfaces :**

Apply the new coating using a flat nylon brush, followed, if necessary, by smoothing with a spalter brush.

- **In the case of an originally roller-brush applied coating :**
Proceed exactly in the same way as with the original coating.

At the end of the retouching operation

Remove the delimiting adhesive tape as soon as the retouching operation is finished.

Replaces and cancels any former issue

The above mentioned information is given with objectiveness but cannot involve our company beyond our manufacturer's responsibility.

ISO 9001 certified since 1996

4 rue du Professeur Dubos – BP 80439 – 60119 Hénonville Cedex (France) – Tél : 33 (0) 3 44 49 86 22 – Fax : 33 (0) 3 44 49 85 00 – Web : www.maxperles.com



**Max
Perlès**
advanced industrial coatings

Technical Advice
Nr.7

August 2019

Engraving of a laminate lining

Scope

This document describes the operations to be carried out to insert a laminate coating into an engraving serving as the end of the area to be coated.

Operation

- Prepare the substrate according to the system specified and to our Technical Advices.
- Trace the limits of the engraving.
- Create a regular engraving 10 to 15 mm high or wide and 10 to 15 mm deep, by any appropriate mechanical means.
- Vacuum-clean carefully of dust.
- Place an adhesive protection starting 10mm away from the engraving, on the side which won't be coated.
- Press the reinforced laminate (topcoat excluded) into the underside of the engraving and sprinkle with Silica sand.
- Fill the engraving with AR100 Render.
- Check for any defects (such as glass fibers standing out), correct and repair.
- Apply the topcoat fully over the engraving, and until the adhesive protection is reached.
- Pull off the adhesive no longer than 10 minutes after the topcoat application.

Sketch

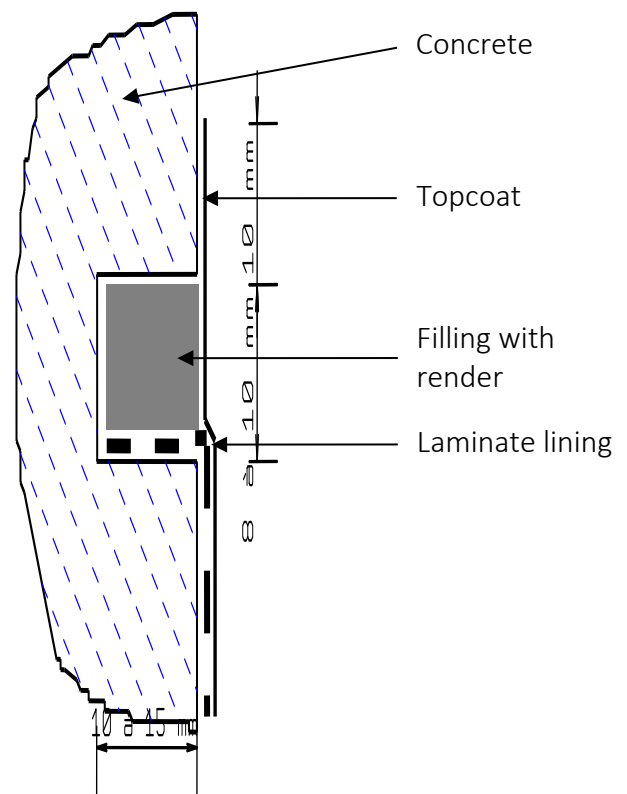

Replaces and cancels any former issue

The above mentioned information is given with objectiveness but cannot involve our company beyond our manufacturer's responsibility.

ISO 9001 certified since 1996

4 rue du Professeur Dubos – BP 80439 – 60119 Hénonville Cedex (France) – Tél : 33 (0) 3 44 49 86 22 – Fax : 33 (0) 3 44 49 85 00 – Web : www.maxperles.com

Implementation of fiberglass/binder laminates

Scope

This document describes the operations to perform to obtain a homogeneous, reinforced, waterproof epoxy or vinylester coating.

Process

1. Prepare, before starting the operation, the required quantities of fiberglass, taking into account the necessary 4 inches / 10 cm wide overlaps and all specific cuts to be done to deal with singular points (curves, rivet lines, seams, columns, penetrations, ...)

2. Make sure that the application work is going to be carried out in the environmental and usage conditions prescribed in the product data sheet.

3. Proceed with the laminate application, making sure no interruption of more than 0h30 to 3 hours ⁽¹⁾ occurs between any two steps:

- **Apply** a first, *impregnation*, coat of the selected resin, using a medium-bristle roller or an airless spray gun, as per the quantity specified in the system sheet.

- **Unroll and lay-out** the fiberglass tissue or mat onto the resin.

- **Debubblize** carefully by strongly cross-rolling the tissue or mat with a debubbling roller ⁽²⁾ until a homogeneous impregnation is obtained. The resin's colour must come up through the tissue/mat, more or less strongly depending on the type and weight of the fiberglass (tissue or mat), knowing that for example a 300 g/sqm fiberglass tissue will "sweat" more, and more easily, than a 900 g/sqm fiberglass mat.

- **Apply** a second, *saturation*, coat of the same resin, using a medium-bristle roller or an airless spray gun, as per the quantity specified in the system sheet, preferably using new cans to benefit from a maximum period of use.

- **Debubblize again** to ensure the resin's penetration through the fibers. At this stage, the surface aspect must be perfectly homogeneous and uniform.

4. If specified in the system sheet being used, repeat the operation, depending on the number of fiberglass layers specified, using each time the *saturation* coat of the previous ply as the next ply's *impregnation* coat. Shift the layers of fiberglass by half a width in order to spread out the zones of overlapping.

5. If specified in the system sheet being used, mechanically sprinkle the still-wet saturation coat, while progressing, with 400 g/sqm of Silica sand (100/300 microns in particle size for our reference F15 , 100/600 microns for our reference SB0), respecting a minimum distance of 1m between the spray nozzle and the laminate. This in order to obtain a uniform surface roughness for proper topcoat adhesion. Use a low-pressure sand pistol.

NB: Taking into account the dispersion resulting from the projection, prepare to use an effective quantity of 600 g/sqm of silica sand on horizontal surfaces, 800 g/sqm on vertical surfaces and 1000 g/sqm on roof undersides.

6. Proceed in the same way on adjacent areas, being sure that overlaps is 10cm on previous tissue or mat.

7. After drying, **sandpaper or very softly grind off** all areas that stand out, such as fiberglass overlaps, for example, and then thoroughly vacuum away any dust.

8. Carry out a general review of the coating in order to detect any defects, as per our *Technical Advice nr.4 " Dielectric Testing "* and proceed with any corrections and repairs as per our *Technical Advice nr.5 " Retouching "*.

9. Apply the specified topcoat on the entire laminated surface, that must be non-condensing.

⁽¹⁾ Depending on the resin used and the temperature of the substrate at the time of use: if in doubt, please consult us.

⁽²⁾ Polyamide, Teflon or aluminum monoblock type rollers.



Waterproof , Watertight and Protective coatings

January 2024
*waste water
manual*

Appendix 4

Reference List



Max
Perlès
revêtements techniques industriels

References list

waste water & desalination

2005

SIAAP - STATION D'EPURATION SEINE AVAL – ACHERES (78)

UPEI⁽¹⁾ : CLARIFLOCCULATION : Sol du bâtiment
LOCAUX ELECTRIQUES : Sol
ACHERES III et IV : Extérieur des dômes

des digesteurs

UPBD⁽²⁾ : ACHERES IV : Bâche à boues
Sols des ateliers machines
Sols des filtres-presses
LABORATOIRE : Sol du bâtiment

VIVENDI WATER / MILLENIUM – LE HODE (76)

Station de traitement des eaux :

Ouvrages de clarification : effluent neutralisé – pH 7,5 à 9,5:

suspension de gypse maxi 250 g/l – t. 47°C (maxi accidentelle 58°C)

DEGREMONT / STATION D'EPURATION LA RICHE – TOURS (37)

Bâche à boues

SIAAP - STATION D'EPURATION SEINE AMONT – VALENTON (94)

Bâche tampon des réactifs sous aire de dépotage de H₂SO₄ et Javel

STEREAU / STATION D'EPURATION DE VITROLLES (13)

Fosse à matières de vidange

Fosse de rétention acide sulfurique

Fosse de rétention eau de Javel

Fosse de rétention hydroxyde de sodium

Fosse de rétention trichlorure de fer

Stockeur de boues (flottateur)

SIAAP - STATION D'EPURATION SEINE CENTRE – COLOMBES (92)

Aire de dépotage des boues

Sol du local pesée

Sol de la salle des refus

STATION D'EPURATION D'ARGELES (66)

Tour de désodorisation acide

STATION D'EPURATION MARBELLA – BIARRITZ (64)

Clarificateur

POSTE DE RELEVAGE – FREJUS (83)

Fosse eaux usées urbaines

2005 (cont'd)

SIAAP - USINE DES EAUX DE CLICHY (92)

Sol du local archives

Sol du local broyeur

Sol du local compacteur

Sol du local pesée

DEGREMONT pour AGUAS ANDINAS

STATION D'EPURATION DE LA FARFANA – SANTIAGO (CHILI)

Digester n°8 : sous-face de coupole – méthane + H₂S

SIAAP - PUIITS DES CORMAILLES – IVRY SUR SEINE (94)

Chambre des vannes

POSTE DE RELEVAGE – SAINT TROPEZ (83)

Fosse eaux usées urbaines

STATION D'EPURATION COCA-COLA – BIERNE (59)

Fosses de rétention acide sulfurique et soude

2006

STATION D'EPURATION DE SIX FOURS (83)

Fosse de récupération eaux usées et eaux pluviales

DEGREMONT / STATION D'EPURATION LA RICHE – TOURS (37)

Digester n°1 : sous-face de coupole – méthane + H₂S

Digester n°2 : sous-face de coupole – méthane + H₂S

SIAAP - STATION D'EPURATION SEINE AVAL – ACHERES (78) **UPEI⁽¹⁾**

ACHERES III : Gazomètre

NITRIFICATION : Aire de dépotage des réactifs

Aire de dépotage méthanol

Bâches à boues flottées

Bâches à centrats

Bâches de reprise

Caniveaux

Carneaux d'air

Flottateurs

Fosses de rétention bisulfite de sodium et soude

STATION DE RELEVAGE – ANTHEUIL PORTES (60)

Puisards

DEGREMONT pour AGUAS ANDINAS

STATION D'EPURATION DE LA FARFANA – SANTIAGO (CHILI)

Digester n°4 : sous-face de coupole – méthane + H₂S

⁽¹⁾ Antérieurement : Usine des Eaux

⁽²⁾ Antérieurement : Traitement Final des Boues

2006 (cont'd)

COMMUNAUTÉ URBAINE DE BORDEAUX STATION D'ÉPURATION CLOS DE HILDE – BEGLES (33)

Bâches des boues digérées
Bâches des boues épaissies
Bâche des boues physico-chimiques Epaisseur
Digesteur : sous-face de coupole – méthane + H₂S
Fosse à graisses
Fosse à matières de vidange
Poste toutes eaux
Stockeur de boues digérées

D.H. WILAYA D'ALGER

STATION D'ÉPURATION DE BARAKI – ALGER (ALGÉRIE)

Bassins d'aération
Bassins de contact
Clarificateurs
Décanteurs
Dessableurs /Déshuileurs
Digesteurs : sous-face de coupole – méthane + H₂S
Épaississeurs

2007

SIAAP – STATION D'ÉPURATION SEINE MORÉE - USINE DE LA BRICHE – ÉPINAY-SUR-SEINE (93)

Sol de la salle des bennes

STATION D'ÉPURATION AMPHYTRIA / CAP SICIE – TOULON (83)

Fosse de rétention FeCl₃

SIAAP - STATION D'ÉPURATION SEINE AVAL – ACHERES (78) UPEI⁽¹⁾ PRETRAITEMENT : Zone dégrillage, plateforme et cage d'escalier

CLARIFLOCCULATION : Sol dit de la « Cour
anglaise »

DESODORISATION : Sol du bâtiment

ACHERES IV : Coursives des flottateurs

UPBD⁽²⁾ Fosse de rétention fuel

OTV / STATION D'ÉPURATION DE ROUSSET (13)

Fosses de rétention acide phosphorique, acide citrique,
ammoniacale, FeCl₃, chlorite de sodium.

ALTIS – CORBEIL ESSONNE (91)

Décanteur à boues EUID S126

⁽¹⁾ Antérieurement : Usine des Eaux

⁽²⁾ Antérieurement : Traitement Final des Boues

2007 (cont'd)

SIAAP - STATION D'ÉPURATION SEINE AMONT – VALENTON (94)

Sphère biogaz

OTV - STATION D'ÉPURATION DE LA PIOLINE – AIX EN PROVENCE (13)

Fosses de rétention FeCl₃, soude, eau et extrait de Javel 40
et 60°GL, alcali, et H₂SO₄ 98%

SIAAP - STATION D'ÉPURATION SEINE GRESILLONS I – TRIEL S/SEINE (78)

Sol du bâtiment chlorure ferrique - 1^{ère} partie

STEREAU / STATION D'ÉPURATION DE VITROLLES (13)

Bâche à boues
Fosse à matières de vidange
Fosse de rétention des réactifs

DEGREMONT pour AGUAS ANDINAS

STATION D'ÉPURATION DE LA FARFANA – SANTIAGO (CHILI)

Digesteur n°7 : sous-face de coupole – méthane + H₂S

S.I.A.A.P. - STATION D'ÉPURATION D'ACHERES IV (78)

Gazomètre n°2 : Intérieur et extérieur

STATION DE METHANISATION DE MONTPELLIER (34)

Bassins et caniveaux : effluents

STATION DE TRAITEMENT D'EAU POTABLE DE TAKSEBT (ALGERIE)

Bac de stockage de sulfate d'alumine 250 g/l, pH 2.5

Bac de stockage de permanganate de potassium 10 à 40
g/l, pH 7 à 9

Bac de stockage de charbon actif 50 g/l

VIVAQUA BELGIQUE

QUAI DE MARIEMONT A MOLENBEEK SAINT JEAN (BRUXELLES)

RUE CHARLES PARENTE (BRUXELLES)

Collecteurs d'eaux usées

2008

SIAAP - STATION D'ÉPURATION SEINE AVAL – ACHERES (78)

UPEI :

PRETRAITEMENT : Aire de déchargement Nutriox
Sol du bâtiment des graisses
Sol de la désodorisation du bâtiment des graisses

DEGREMONT pour AGUAS ANDINAS

STATION D'ÉPURATION DE LA FARFANA – SANTIAGO

(CHILI)

Digesteur n°1806 : sous-face de coupole - méthane + H₂S

SIAAP - STATION D'ÉPURATION SEINE AVAL – ACHERES (78)

UPEI :

ACHERES IV : Gazomètre n°2 Extérieur/Intérieur de la cloche du gazomètre et radier

RADEEMA - STATION D'ÉPURATION DE MARRAKECH

(MAROC)

Digesteurs (x2) : sous-face de coupole - méthane + H₂S

STATION D'ÉPURATION DE CORBEIL (91)

Gazomètre aérien : Intérieur de la cloche

SIAAP - STATION D'ÉPURATION SEINE AVAL – ACHERES (78)

UPEI :

PRETRAITEMENT : Rétention FeCl₃

SIAAP - STATION D'ÉPURATION SEINE GRESILLONS I – TRIEL

S/SEINE (78)

Sol du bâtiment chlorure ferrique – 2^e partie

OTV / STATION D'ÉPURATION DE LA PIOLINE – AIX EN

PROVENCE (13)

Rétention Javel, FeCl₃, NaOH, H₂SO₄

D.H. WILAYA D'ORAN

STATION D'ÉPURATION D'ORAN (ALGÉRIE)

Digesteur : sous-face de coupole - méthane + H₂S

SIAAP – STATION D'ÉPURATION SEINE AVAL - USINE DE PRETRAITEMENT DE LA FRETTE – ACHERES (78)

Bâtiment dégrilleurs : Sol et murs

DEGREMONT pour AGUAS ANDINAS

STATION D'ÉPURATION DE LA FARFANA – SANTIAGO

(CHILI)

Digesteur n°1803 : sous-face de coupole – méthane + H₂S

2009

SIAAP - STATION D'ÉPURATION SEINE AVAL – ACHERES (78)

UPEI :

PRETRAITEMENT : sol du bâtiment des graisses

ACHERES III : sol de la salle des pompes
goulottes des décanteurs primaires CP1
et CP3

ACHERES IV : goulottes des décanteurs primaires CP2,
CP4, CP6 et CP8

SAUR / STATION D'ÉPURATION DE BOURG D'OISANS (38)

Rétention FeCl₃

OTV / STATION D'ÉPURATION DE BONNEUIL (94)

Gazomètre

SIAAP - STATION D'ÉPURATION SEINE CENTRE – COLOMBES (92)

Tours de désodorisation de la file 1 : n°1, 2^(*), 3^(*) et 4
^(*) en AR100/MD6

SAUR / STATION D'ÉPURATION DE MOUTIERS (73)

Rétention FeCl₃

OTV / STATION D'ÉPURATION D'ALBI (81)

Digesteurs (x2) : sous-face de coupole - méthane + H₂S

SIAAP - STATION D'ÉPURATION SEINE GRESILLONS I – TRIEL S/SEINE (78)

Sol de la salle traitement des sables

Sol de la salle des pompes

OTV / STATION D'ÉPURATION DE HYERES (83)

Bâche à boues digérées

Digesteur : sous-face de coupole - méthane + H₂S

Plénum d'air vicié

Réception et stockage de matières de vidange

Rétentions réactifs : FeCl₃, soude, Javel, acide sulfurique,
acide phosphorique

SIAAP – STATION D'ÉPURATION SEINE AVAL - USINE DE PRETRAITEMENT DE LA FRETTE – ACHERES (78)

Sol du bâtiment arrivée des émissaires

VINCI ENVIRONNEMENT / STATION D'ÉPURATION DE MONTEUX (83)

Bâche à membrane Ultrabox

Bâche de vidange Ultrabox

Fosse électrolyse des graisses

Rétention dépotage réactifs

DEGREMONT pour AGUAS ANDINAS

STATION D'ÉPURATION DE LA FARFANA – SANTIAGO

(CHILI)

Digesteur n°1805 : sous-face de coupole - méthane + H₂S

2010

SIAAP - STATION D'EPURATION SEINE AVAL – ACHERES (78) **UPEI :**

PRETRAITEMENT : Sol du bâtiment désodorisation

ACHERES III : Gazomètre

ACHERES IV : Sol et murs des galeries

COMMUNAUTE D'AGGLOMERATION DE LA ROCHELLE **STATION D'EPURATION DE PORT NEUF (17)**

Tour de désodorisation biologique

Bassin tampon

DEGREMONT pour AGUAS ANDINAS

STATION D'EPURATION DE LA FARFANA – SANTIAGO **(CHILI)**

Digesteur n°1802 : sous-face de coupole - méthane + H₂S

STATION D'EPURATION DE JERSEY – ILE DE JERSEY

Bâche à boues

SIAAP - STATION D'EPURATION SEINE AVAL – ACHERES (78) **UPEI :**

DERU – Bâtiment Fiabilisation :

Bâche à boues épaissies BID 20-21

Bâche à boues primaires BID 22-23

Bâtiment KB02 :

6 bassins membrane KBE 20 à 25

Bâtiment KBE66 :

Bâches à boues 51-52-53

Carneaux d'air vicié

Bâtiment KC01 :

Plénum 26-50 et 29-35

Bâtiment KC01 et KC02 :

Rétention réactifs KCD 32-33-34

Bâtiment KB03 :

Bâche toutes eaux KBE42

Bâches à boues flottées KBE45 et KBE50

Bâche d'arrivée KBE58-60

Fosse échangeurs KBE57

Bâche de dégazage KBE41 et KBE49

Bâche à boues communes KBE48

Surverse et répartiteurs flottateurs

KBE51, KBE52 et KBE53

STATION D'EPURATION DE VALLOUISE (05)

Bâche à eaux usées

SIAAP - STATION D'EPURATION SEINE GRESILLONS I – TRIEL **S/SEINE (78)**

Bâtiment C10 : Sol de l'atelier

OTV – STATION D'EPURATION DE SAINT LAURENT DU VAR (06)

Zone bassin biologique sud : sous-face de couverture des décanteurs

2010 (cont'd)

STATION D'EPURATION DE CHAMBERY (73)

Fosse toutes eaux

STATION D'EPURATION DE LAVAL (53)

Digesteurs (x2) : sous-face de coupole - méthane + H₂S

Stockeur des boues primaires

Stockeur des boues digérées

OTV – STATION D'EPURATION DE LA PIOLINE – AIX EN **PROVENCE (13)**

Bâche à boue extérieure

Bâche à boues de stockage épaissies

Bâche de surverse

Fosse toutes eaux

COMMUNAUTE URBAINE DE BORDEAUX

STATION D'EPURATION DU CLOS DE HILDE – BEGLES (33)

Stockeur 61 : sous-face, et Petite fosse

2011

STATION D'EPURATION DE CHAMBERY (73)

Prétraitement : Décanteur lamellaire

Bâche de floculation

Fosse toutes eaux

STATION D'EPURATION DE BRIOUDE (43)

Prétraitement : Poste de relevage

Dégrilleur

SYNDICAT D'ASSAINISSEMENT COLLECTIF DU CANTON DE **L'OISANS (38)**

Regards d'eaux brutes et pluviales

COMMUNAUTE URBAINE DE BORDEAUX – STATION **D'EPURATION LOUIS FARGUE (33)**

Postes toutes eaux

Rétentions et massifs

Fosses dépotage et traitement

Rétention chlorure ferrique

S.E.M. 12 - STATION D'EPURATION D'ESPALION (12)

Fosse de dépotage

Fosse de traitement des produits de curage

Rétention chlorure ferrique

2011 (cont'd)

**SIAAP - STATION D'EPURATION SEINE AVAL – ACHERES (78)
UPEI**

DERU – Bâtiment KB02 :
 Bassins KBE20 à 25
 Cheminée d'air vicié KBE66
 Bâtiment KB03 (R.T.O) :
 Bâche d'arrivée KBE58 et 60
 Fosse échangeur KBE57
 Bâche toutes eaux KBE42
 Bâtiment KB03 (Flottation) :
 Bâche à boues flottées KBE46 à KBE50
 Bâche de dégazage KBE47 à 49
 Bâches à boues communes KBE48,
 KBD48, KBD51, KBD52
 Répartiteurs flottateurs KBE51, KBE52,
 KBE53
 Bâches surverses KBE56
 Bassins flottation KBD54 et KBD56
 Bâtiment KC01 :
 Tours de désodorisation KCD20
 Plénum niveau +26,5 KCD39
 Plénum niveau +29,35 KCB17
 Bâtiment KC02 :
 Rétention des réactifs KCD27 à KCD29
 Bâtiment KC03 :
 Bâche de rétention KCD32 à 34
 ACHERES IV : Sol des galeries

SIAAP – USINE DES EAUX – CLICHY (92)

Cuve à fuel

**METROPOLE NICE COTE D'AZUR – STATION D'EPURATION
SAINT-LAURENT DU VAR (06)**

Bassins (x2) Biosep sud
 Bâche à boues

DEGREMONT pour AGUAS ANDINAS

STATION D'EPURATION DE MAPOCHO – SANTIAGO (CHILI)
 Digesteur FE1C n°9 : sous-face de coupole - méthane + H₂S

2011 (cont'd)

**SIAAP - STATION D'EPURATION SEINE MOREE – BLANC
MESNIL (93)**

Bâtiment C :
 Bassin tampon
 Poste toutes eaux
 Canal de distribution tamis
 Bâche de comptage des eaux brutes
 Canal de distribution de dégrillage
 Bâtiment D :
 Bâche de stockage des eaux sales
 Bâtiment E :
 Epaississeurs 1 et 2
 Poste toutes eaux
 Bâtiment F :
 Local désodorisation
 Aire de dépotage camions
 Fosses de rétention des réactifs
 Bâtiment G :
 Bâches à boues primaires 1 et 2
 Bâches de mélange 1 et 2
 Bâches à boues épaissies
 Poste toutes eaux
 Bâtiment déminéralisation :
 Caniveaux nord et sud

2012

STATION D'EPURATION PAYS DE MONTMELIAN (73)

Prétraitement : Canal et bassin d'aération
 Dégrilleur

STATION D'EPURATION CHAMBERY METROPOLE (73)

Ouvrages hydrauliques : Bâche à boues
 Bâche matières de vidange

**SYNDICAT MIXTE DU BASSIN DE L'OR – STATION
D'EPURATION DE LA GRANDE MOTTE (34)**

Bâches (x4) de relevage

SIAAP - STATION D'EPURATION SEINE AVAL – ACHERES (78)

UPEI :
 ACHERES IV et V : Goulottes des flottateurs

STATION D'EPURATION DE ROUSSET (13)

Bâches (x3) accidentelles d'effluents industriels

COCA-COLA TOULOUSE (31)

Fosse de rétention de récupération des eaux de pluie

2012 (cont'd)

SIAAP – STATION D'EPURATION SEINE MOREE – BLANC MESNIL (93)

Local réactifs :
Poste de relevage
Salle des membranes
Bâtiment désodorisation :
Caniveau et gaine de ventilation
Bâche à boues

SIAAP - STATION D'EPURATION SEINE LES GRESILLONS II – TRIEL-SUR-SEINE (78)

Bâtiments C10 et C11 :
Sols
Bâtiment E23 :
Regard
Bâtiment D21 :
Caniveau

SIAAP - STATION D'EPURATION SEINE CENTRE – COLOMBES (92)

Tours de désodorisation de la file 3 :
tours acides n°1 et 4,
tours basiques n°2 et 3

2013

SIAAP - STATION D'EPURATION SEINE AVAL – ACHERES (78) UPEI :

PRETRAITEMENT :
Carneaux
Bâche à boues primaires
Bâtiment d'arrivée des émissaires : sol et

murs

CLARIFICATION :
Aire de dépotage de chlorure ferrique

STATION D'EPURATION DE CUZCO (PEROU) Bâche à boues n°1 à la chambre des boues

SIAAP - STATION D'EPURATION SEINE CENTRE – COLOMBES (92)

Tours de désodorisation de la file 4 :
tours acides n°1 et 4,
tours basiques n°2 et 3

SIAAP – STATION D'EPURATION SEINE MOREE – BLANC MESNIL (93) Aire de dépotage d'acide sulfurique 98%, soude et thiosulfate

INEOS – MARTIGUES (13)
Station WWTP2 – Décanteurs (x2) à eaux industrielles

2013 (cont'd)

SIAAP - STATION D'EPURATION SEINE GRESILLONS II – TRIEL S/SEINE (78)

Rétention chlorure ferrique

AGUAS ANDINAS

STATION D'EPURATION DE TALAGANTE – SANTIAGO (CHILI)
Digesteur n°1 : sous-face de coupole – méthane + H₂S

STATION D'EPURATION DE CHAMBERY (73)

Prétraitement – caniveaux

STATION D'EPURATION DE ROUSSET (13)

Bâche à boues
Bassin d'homogénéisation

STATION D'EPURATION DE PONT DU CASSE (47)

Bassin d'aération

SIAAP - STATION D'EPURATION SEINE AMONT – VALENTON (94) Digesteur n°1

COSAPI pour SEDACUSCO

STATION D'EPURATION DE CUZCO – SAN JERONIMO (PEROU)
Digesteur n°2 – méthane + H₂S

2014

STATION D'EPURATION DE TOURS – LA RICHE (37)

Bassin clarificateur n°1

CHU LA COLOMBIERE – MONTPELLIER (34)

Fosse eau et hydrocarbures

STATION D'EPURATION D'ESTANTENS – MURET (31)

Bâche à boues

SIAAP – STATION D'EPURATION SEINE AVAL – ACHERES (78) UPEI

Reprises bâches BDI 22 et 23
Massifs adoucisseurs
Prétraitement carneaux

SIAAP - STATION D'EPURATION SEINE AMONT – VALENTON (94) Digesteur n°1 (suite)

SIAAP - STATION D'EPURATION SEINE CENTRE – COLOMBES (92)

Tours de désodorisation de la file 2 :
tours acides n° 1 & 4
tours basiques n° 2 & 3

LIGNIERES DE TOURAINE (37)

Poste de refoulement

2014 (suite)

STATION D'EPURATION DE LUXFER – GERFAL (63)

Décanteur

Stock boues + clarificateur

AJINOMOTO EUROLYSINE – AMIENS (80)

Caniveau circulaire du décanteur

SIAAP – STATION D'EPURATION SEINE GRESILLONS – TRIEL SUR SEINE (78)

Aire de dépotage méthanol

2 silos boues déshydratées.- Bâtiment B12

Rétention chlorure ferrique.

STATION D'EPURATION ISOLA 2000 – NICE (06)

Rétentions 3 locaux : ammoniacque, compostage – chaux éteinte.

STATION D'EPURATION DE CHACE VARRAINS (49)

Poste de refoulement PR2 & 3

2015

SIAAP – STATION D'EPURATION SEINE AMONT – VALENTON (94)

Sequaris Bâtiment 11107 – Rétention FeCl3

Reprises dans stockeur

SIAAP – STATION D'EPURATION SEINE AVAL – ACHERES (78) UPEI

PRETRAITEMENT :

- Bassins dessablement

FILE BIOLOGIQUE :

- Zones MCR, MMA et MMB

BATIMENTS CENTRIFUGATION :

- Désodorisation et Réactifs

CENTRALE DE COGÉNÉRATION BIOMASSE – VIELLE SAINT GIRONS (40)

Fosse fumée et fosse de rétentions GTA et local électrique

STATION D'EPURATION DE VILLENEUVE MAGUELONNES (34)

Décanteur en bassin d'orage

EPAD OUEST PROVENCE - ISTRES (13)

Fosse des eaux usées de Saint Chamas

STATION D'EPURATION DE PRESSIGNY (37)

Poste de refoulement

UNITÉ DE VALORISATION ÉNERGÉTIQUE DE BENESSE MARENNE (40)

Complexe ACR

Fosse toutes eaux, locaux déminé, NH3, GTA, fosses transformateurs, stockage GTR

2015 (cont'd)

SIAAP – STATION D'EPURATION SEINE GRESILLONS – TRIEL SUR SEINE (78)

Bâtiment E20 déshydratation – sol

SIAAP – STATION D'EPURATION SEINE AVAL – ACHERES (78) UPEI

Bassins dessablement – chemins de circulation

SIAAP – STATION D'EPURATION SEINE AVAL – ACHERES (78) UPEI – DERU

- Bâtiment TDJ – Bâche de surverses flottation KBE 56 – poste toutes eaux KBE 42

- Nitrification bâche JTC45

STATION D'EPURATION DE RIEUX MONCHAUX (76)

Bassin d'aération – boues activées

TAMISIER ENVIRONNEMENT – ISLE SUR LA SORGUE (84)

Unité de bio méthanisation – Liquéfacteur

VILLE DE CAUMONT SUR DURANCE (84)

Poste de relevage de la station d'épuration

SIGDO KOPPERS pour AGUAS ANDINAS

STATION D'EPURATION DE MAPOCHO 4 – SANTIAGO (CHILI)

Digesteurs C et D : sous-face de coupole – méthane + H₂S

2016

RATP – LIGNE 7 CLICHY – PARIS

Égouts

SIAAP – STATION D'EPURATION SEINE AVAL – ACHERES (78)

Bassins membranaires Files A & B

SIAAP – STATION D'EPURATION SEINE AMONT – VALENTON (94)

Bâche à écume

Digesteur DG3

COOPÉRATIVE LÉGUMIÈRE « LA ROSÉE DES CHAMPS » - DOUE LA FONTAINE (79)

Cuve de méthanisation

2016 (cont'd)

SIAAP – STATION D'ÉPURATION SEINE AVAL – ACHERES (78) UPEI

BATIMENTS CENTRIFUGATION :
Locaux JCC11 & JCC21
BATIMENT DÉSODORISATION :
Locaux JCD05, 02 et 03
BATIMENT REACTIFS :
Locaux JCR08, 09, 10, 12, 13, 15, 22, 23, 25
PRETRAITEMENT :
Chemin de circulation piétons et véhicules
Bassins de dessablement
Bandes de roulement des ponts
Carneaux zones PAZ 13 et AKD
Cuves de rétention divers effluents
Regards et caniveaux
Aire de dépotage

SIAAP – STATION DE POMPAGE – CROSNE (91) Rétention eau de javel et soude

SIA – SYNDICAT INTERCOMMUNAL d'ASSAINISSEMENT – COGOLIN GASSIN (83) Réhabilitation des prétraitements de la STEP de Font Mourier - Canaux de dégrillage - Dessableurs/dégrilleurs

SIAAP – STATION D'ÉPURATION SEINE GRESILLONS – TRIEL SUR SEINE (78) Bâches à boues digérés

STATION D'ÉPURATION EDELWEISS – LE HAVRE (76) Zone lamellaire canal de sortie des eaux usées Puits de chute PRI Regard PRI

DEGREMONT pour AGUAS ANDINAS STATION D'ÉPURATION DE MAPOCHO 4 – SANTIAGO (CHILI) Réservoirs de boues digérées : Voiles

STATION D'ÉPURATION DE SAINT-JEAN D'AULPS (74) Stockage de boues Zones de dépotage / stockage des réactifs (H₂SO₄, NaOH et FeCl₃)

VEOLIA – AIGUEBLANCHE (73) Bâche à boues

SIAEP (SYNDICAT INTERCOMMUNAL D'ADDUCTION D'EAU POTABLE) MARCHE BOISCHAUT – SIDIAILLES (18) Usine de Chamblan – bâches à boues

STEP DU REYRAN - Fréjus (83) Ouvrages d'arrivée (5)

2017

SIAAP – STATION D'ÉPURATION SEINE AVAL – ACHERES (78) UPEI

PRETRAITEMENT :
Carneaux zones PAZ 13 et AKD
Cuves de rétention divers effluents
Regards et caniveaux
Aire de dépotage
PRETRAITEMENT 2^{ème} Tranche :
15 Bassins de dessablement
Bandes de roulement des ponts
Chemin de circulations piétons et véhicules

COMMUNAUTÉ DE COMMUNES DU PAYS ROUSSILLONNAIS - STATION D'ÉPURATION DES BLACHES (38) Fosses à graisses et matières de vidange Postes toutes eaux Bâche à boues épaissies Poste de relevage nord et sud, puits d'équilibrage

STATION D'ÉPURATION DES SAINTES MARIES DE LA MER (13) Poste de relevage Dessableur, déshuileur et fosse à graisses Réacteur désodorisation : relevage intermédiaire Local boues Aire de dépotage et dalle support FeCl₃ Bâche à eau

MONISTROL SUR LOIRE (43) Cuvelage du bassin de dépollution

SIAAP – STATION D'ÉPURATION SEINE GRESILLONS – TRIEL SUR SEINE (78) Bâches à boues digérées

SITE du FAYET – FRONTENEX (74) Bâches eaux sales

SYNDICAT INTERCOMMUNAL VAL D'ANZIEUX ET PLANCIEUX - MONTROND LES BAINS (42) Bassin de stockage eaux usées

SIAAP - STATION D'ÉPURATION SEINE AMONT - VALENTON (94) Vasques de digesteur

SAMRA WATTEWATER TREATMENT - JORDANIE Digesteur 1

VEOLIA – AIGUEBLANCHE (73) Bâche à boues

MAPOCHO – CHILI Digesteurs 1 et 2

2018

SIAAP – STATION D'ÉPURATION SEINE AVAL – ACHERES (78) UPEI

PRETRAITEMENT 2^{ème} Tranche :
15 Bassins de dessablement

SAMRA WATERTREATMENT - JORDANIE Drainage pit 101

SI DES BASSINS DE LA THEVE ET DE L'YSIEUX – COYES LA FORÊT (60) Bassins PR7 & PR8

STEP INDUSTRIELLE AQUAVAL – LE ROUSSET (13) Bassin de clarification 1 & 2 – filière 2, une aire de dépotage et une rétention

SIAAP MABOC SAV (78) 2 cuves NUTRIOX

SYNDICAT INTERCOMMUNAL VAL D'ANZIEUX ET PLANCIEUX - MONTROND LES BAINS (42) Bassin de stockage

CC DU PAYS ROUSSILLONNAIS – STEP DES BLACHES (38) Station d'épuration 80000 EH

SIAAP ALFORTVILLE (94) Bassins de l'Usine de prétraitement 1^{ère} tranche - canal 3

CU GRAND PARIS SEINE ET OISE – STEP DES MUREAUX (78) Canaux de prédégrillage et postes toutes eaux Bâches à graisses Fosse à flottant sedipac + trémie Bâches à boues Fosse de reprise de boues biologique Canal de répartition Épaississeurs Aire de rétention et dépotage des réactifs

SIAAP COLOMBES (92) Aire de dépotage

SIAAP ALFORTVILLE (94) Usine de prétraitement – bassins

NIMES METROPOLE – STEP DE ST GILLES (30) Bassin d'orage Canaux Dégraisseur / Dessableur

MAPOCHO – CHILI Digesteur n°3

2018 (cont'd)

SYNDICAT PUY DES FOURCHES - VEZERE (19) – UNITE DE TRAITEMENT DES CARDERIES

Bâche d'eau sale
Rétention et aire de dépotage FeCl3

STEP DE BOURG D'OISANS – AQUAVALLEES (38) Bâches à boues Rétentions

2019

AXENS SALINDRE (30) Bassin carbone

SIAAP ACHERES (78) Sols Désodorisation Clarification Local air Maboc

MEXIQUE – SAN LUIS POTOSI Usine d'assainissement Dégraisseurs et Canaux latéraux

ST PRIEST (69) Bâche coagulation homogénéisation

STEP DE MONT – COMMUNAUTE D'AGGLOMERATION CREIL SUD OISE (60) Digesteur

STEP DE GINESTOUS – METROPOLE DE TOULOUSE (31) Prétraitement – Digesteurs – Bâches et cuves 2^{ème} Digesteur

STATION AMPHORA - METROPOLE TOULON PROVENCE MEDITERRANEE (83) Rétention + aire de dépotage H2O2 50%

STEP DES MUREAUX – CU GRAND PARIS SEINE ET OISE (78)

STEP DE ST GILLES – NIMES METROPOLE (30) Bassin d'orage – Canaux – Dégraisseur / Dessableur

STEP DE ST JORY – (31) Canaux de dégrillage

SIAAP CHARENTON (94) Fosse de désodorisation & Rétention

ARLANC (63) Regard béton

2019 (cont'd)

SIAAP ALFORTVILLE (94)
Usine Prétraitement Bassins

SIAAP ACHERES 3 (78)
Bâtiment filtre presse
Reprise des sols
Sphère Biogaz

STEP DE PERPIGNAN (66)
Rétentions
Fosse de l'aire de dépotage

STEP DE BOURG D'OISANS (38)
Rétentions

STEP DE PORT SAINT LOUIS (13)
Ouvrages d'arrivée

STEP DE PORT DOUVOT (25)
Bâches – Postes toutes eaux – Fosse à graisse

MAPOCHO - CHILI
Digesteur 4

LA FARFANA - CHILI
Station de traitement d'Azote

SINFRA – COTE D'IVOIRE
Station de traitement PK 24

2020

STEP DE PORT DOUVOT (25)
Bâches – Postes toutes eaux – Fosse à graisse

SIAAP ACHERES – Unité de production BIOGAZ (78)
Atelier d'homogénéisation – Stockeur S2
Bassins TDJ

CONSTELLIUM - ISSOIRE (63)
Bac de contrôle ultrason U101

EIFFAGE – SEVADEC Calais (62)
Digesteur – cuves à jus – sols

VILLE DE LIBOURNE (33)
Bassin de stockage effluents

GTR7 MONTAUBAN (82)
Canalisations eaux usées

STEP DE GINESTOUS – METROPOLE DE TOULOUSE (31)
Prétraitement – Digesteurs – Bâches et cuves
2^{ème} Digesteur

SI DES BASSINS DE LA THEVE – COYES LA FORET (60)
Bâches PR7 et PR8

SIAAP ACHERES 4 – UPBD (78)
Bâtiment filtre presse

STEP de SAINT BERNARD – BAYONNE (64)

GEP NICE (06)
Canalisations eaux usées

STEP de HYERES (83) – VEOLIA

STEP DE PERPIGNAN (66)
Postes toutes eaux n°2

STEP du HAVRE (76)
Densadeg

SILA Synergie CHAVANOD (74)
Bâche toutes eaux

STEP GALERIA (20)

2021

VILLE DE LIBOURNE (33)

Bassin des Tonneliers, IR Souchet et PR De Lattre de Tassigny

METROPOLE AIX-MARSEILLE (13)

STEP de FOS-SUR MER – Zones A, B, C et prétraitement

SYNDICAT MIXTE GARRIGUE-CAMPAGNE (34)

STEP de St Hilaire de Beauvoir – local stockage réactifs

COMMUNE DE BOULLEVILLE (27)

Poste eaux usées

STEP DE BOEN (42)

STEP DE NIMES (30)

SIAAP ACHERES (78)

Aires de dépotage NIT, VBH-EZ-KCD42-001 & BIC 23

STEP DE LANDOUERRAT

Bassin d'aération

STEP FROMAGERIE GILLEY (25)

Bassin tampon

STEP DE JOUANAS (40)

Aire de dépotage

SIAAP SEINE AVAL – Achères (78)

Unité Biogaz – 11 digesteurs

SIAAP SEINE AVAL – Achères (78)

Décantation Primaire

SIAAP SEINE AVAL – Achères (78)

Décantation Primaire – Zone DP2

SIAAP SEINE AVAL – Achères (78)

Aire de dépotage

2022

SIAAP SEINE AVAL – Achères (78)

Décantation Primaire

SIAAP SEINE AVAL – Achères (78)

Unité Biogaz – 11 digesteurs (suite)

METROPOLE DU GRAND NANCY (54)

STEP Maxeville – Stockeur de boues

SIAAP VALENTON (94) - SESAME

Bâche de refoulement

BORDEAUX METROPOLE (33)

Postes de refoulement Bourran & Vallon

JORDANIE

Digesteur 102B

CORSE – STEP LA MARANA

Prétraitement – ciel gazeux

POLYNT (62)

Bassin de décantation

LA FARFANA - CHLI

Digesteur 1808

ALVA à REZE (44)

Bassin tampon BT600

SIAAP VALENTON (94) – Unité de Désinfection

Rétentions et aires de dépotage

STATION D'EPURATION DE BAGES (66)

Poste de relevage - Dégrillage

2023

HALIOTIS - NICE (06)

Plots des clarificateurs

USINE VALEDEAU DE MONTPELLIER (34)

Zones Réactifs, Coagulation, Relevage, Aquadaf

STEP DE LA BASE AERIENNE – EVREUX (27)

Digesteur n°2 et bassin de surverse

SIAAP SEINE AVAL – Achères (78)

Modernisation de l'unité Biogaz - Bâtiments Annexe

VILLE DE VIRY CHATILLON (91)

Cellule eau brute Tr1 – Aire de dépotage

COMMUNAUTE D'AGGLOMERATION DE LA RIVIERA

STEP DE MENTON

Tours de désodorisation

STEP DE PIOLENC - COMMUNAUTE DE COMMUNES

AYGUES OUVÈZE EN PROVENCE (84)

Dégraissage, dessablage, poste toutes eaux, fosse à graisse, silo à boues

SIAM (77) – STEP DE ST THIBAUT DES VIGNES

Décanteur T4

MONTPELLIER (34) – STEP MAERA)

1 Digesteur

SETE AGGLOMERATION (34)

STEP des Eaux Blanches – Renforcement de capacité

DJIBOUTI – STATION D'EPURATION DE BALBALA

Extension